

ALLEN & HEATH

GL4000

Dual Function Audio Mixing Console

USER GUIDE

PUBLICATION: AP2642

GL4000

USER GUIDE

CONTENTS

Warranty	2
Introduction	3
Overview	4
Range and Options	5
Dimensions and Weights	6
Specifications	7
System Block Diagram	8
Connectors	10
Earthing	13
Connecting the Power Unit	14
Matching the Signal Levels	15
Mono Input Channel	16
Stereo Input Channel	18
Stereo Channel Applications	19
Group Section	20
LR Section	21
Mono and Master Section	23
The Mute System	26
Mute Groups	28
Mute Safes	31
Mute Patches	32
The Patch Display	33
QuickSolo	36
Solo Safes	37
MIDI	38
Technical Support	42
Front-of House Application	44
On-Stage Monitor Application	48
Multi-Speaker System Application	51
Internal Link Options	52
Panel Layout Drawing	rear cover

LIMITED ONE YEAR WARRANTY

This product has been manufactured in the UK by ALLEN & HEATH and is warranted to be free from defects in materials or workmanship for a period of one year from the date of purchase by the original owner.

To ensure the high level of performance and reliability for which this equipment has been designed and manufactured please read this User Guide before use.

In the event of a failure notify and return the defective unit to ALLEN & HEATH or its authorised agent as soon as possible for repair under warranty subject to the following conditions:

CONDITIONS OF WARRANTY

1. The equipment has been installed and operated in accordance with the instructions in the User Guide.
2. The equipment has not been subject to misuse either intended or accidental, neglect, or alteration other than as described in the User Guide or Service Manual, or approved by ALLEN & HEATH.
3. Any necessary adjustment, alteration, or repair has been made by ALLEN & HEATH or its authorised agent.
4. The defective unit is to be returned carriage prepaid to ALLEN & HEATH or its authorised agent with proof of purchase.
5. Units to be returned should be packed to avoid transit damage.

These terms of warranty apply to UK sales. In other territories the terms may vary according to legal requirements.



This product complies with the European Electromagnetic Compatibility Directives 89/336/EEC & 92/31/EEC and the European Low Voltage Directives 73/23/EEC & 93/68/EEC.

ALLEN&HEATH



MANUFACTURED IN THE UNITED KINGDOM

Allen & Heath Limited.
Kernick Industrial Estate,
Penryn, Cornwall, TR10 9LU.
<http://www.allen-heath.com>

INTRODUCTION

The **GL4000** continues ALLEN & HEATH's commitment to provide high quality audio mixing consoles engineered to meet the exacting requirements of today's audio business. It brings you the latest in high performance technology and offers the reassurance of over two decades of console manufacture and customer support.

This user guide presents a quick reference to the function and application of the **GL4000**. For further information on the basic principles of audio system engineering please refer to one of the specialist publications available from bookshops and audio equipment dealers.

Whilst we believe the information in this guide to be reliable we do not assume responsibility for inaccuracies. We also reserve the right to make changes in the interest of further product development.

SERVICE AND TECHNICAL SUPPORT

Under normal conditions the **GL4000** does not require user maintenance or internal calibration. In certain cases it may be necessary to reconfigure internal option links. This and any service work required should be carried out by qualified service or engineering personnel only.

We are able to offer further product support through our worldwide network of approved dealers and service agents. To help us provide the most efficient service please keep a record of the console serial number, and date and place of purchase to be quoted in any communication regarding this product.



SAFETY WARNING



Mains electricity is dangerous and can kill. Mains voltage is present within the power supply unit provided with the console. Do not remove the power unit cover with mains connected. The correct mains voltage setting is indicated on the rear of the power unit. Check your mains wiring and earthing before switching on.

DO NOT REMOVE THE MAINS EARTH CONNECTION!

The console chassis is connected to mains earth to ensure your safety. Audio 0V connects to the console chassis internally. Should problems be encountered with ground loops operate the audio ground lift switches on connected equipment accordingly or disconnect the cable screens at one end. Refer to the section on 'EARTHING' later in this User Guide.

GENERAL PRECAUTIONS

- **POWER SUPPLY** Use only the power unit specified for the console. Check the unit for correct AC mains voltage setting before switching on. Allow adequate space around the unit for ventilation.
- **CONNECTIONS** Use audio connectors and cables only for their intended purpose. Do not connect any source of AC or DC power to the console audio connectors. Do not connect the output of power amplifiers directly to the console.
- **CLEANING** Avoid the use of chemicals, abrasives and solvents. The control panel is best cleaned with a soft brush and dry lint-free cloth. To remove stubborn marks (such as chinagraph pencil) isopropyl alcohol may be used.
- **LUBRICATION** The faders, switches and potentiometers are lubricated for life. The use of electrical lubricants on these parts is not recommended.
- **DIRT, DUST, SMOKE and MOISTURE** Prevent damage to the moving parts, such as faders and potentiometers, and cosmetics by avoiding drinks spillage, tobacco ash, smoke, and exposure to rain and condensation. Protect from excessive dirt, dust, heat and vibration.

GL4000

OVERVIEW

The **GL4000** offers the professional user an uncompromised feature set and performance for live sound engineering and recording. The console is available in 24, 32, 40 and 48 channel sizes with an external 3U rack power unit. Options include bolt-on expander module, SYS-LINK interconnect system and 1U dual power supply monitor/combiner unit. Units from Serial Number 403421 include a built-in VU Meterpod as standard. An optional VU Meterpod is available for earlier units.

- **Dual function + live recording capability :**
 - Large venue Front-of-House
 - Dedicated 12 buss (10mix+LR) stage monitor
 - Dual function combines Front-of-House and monitor
 - Live recording to 2-track and multitrack
- 24, 32, 40, 48 frame sizes including VU Meterpod
- Stereo models include mic/stereo line channels depending on customer specification
- 8 groups with inserts and trimmable balanced XLR outputs
- L,R,M mix on balanced XLR and with inserts
- 10 Aux sends on balanced XLR and with inserts
- 4 Matrix capable of balanced XLR and inserts
- Matrix to aux link feature for group effects and monitors
- Secondary LR output capable of balanced XLR and inserts
- Channel Direct outputs with level trim and pre/post
- 4 band full sweep channel EQ with mid Q switches
- Stereo channel 4-point width control
- Separate insert jacks with balanced returns
- MIDI mute system with 128 patches
- 8 independent mute groups
- Solo-in-place with QuickSolo feature
- Full metering - channel, mix buss and outputs.
- Monitor with stereo PFL, local output, 2 phones ...
- Simultaneous stereo and mono PFL metering
- Output meter selector switches for main or aux
- Talkback to L-R, M, groups, matrix, and to each aux
- 2-track replay to L-R and monitor

The console is constructed using extruded aluminium beams, steel panels and 3mm thick metal side plates to ensure rigidity and mechanical reliability on the road, as well as easy flightcasing. Individual circuit assemblies are accessible by removal of the steel base. A durable but soft front armrest is provided for comfort. Front, top and rear write-on strips are provided for channel marking. High quality proven reliable parts are used throughout. High performance op-amp and discrete circuits are used to ensure low noise and sonic purity.

The **GL4000** reflects our commitment to providing the best audio mixing solutions and customer support.

THE RANGE

The following **GL4000** models and options are available. For further details please contact your Allen & Heath agent :

GL4000-824 - 24 channel console

GL4000-832 - 32 channel console

GL4000-840 - 40 channel console

GL4000-848 - 48 channel console

The Stereo models can include mic/stereo line channels dependant on customer specification. The console is supplied with separate power supply, DC power cable and mains cable with moulded plug.

GL4000-8M - 8 mono channels expander

GL4000-4SM - 4 stereo, 4 mono expander

GL4000-4MS - 4 mono, 4 stereo expander

These expander modules are fitted by removing the console side plate, attaching to the chassis, and plugging in the harnesses. The console may be expanded to a maximum of 48 channels.

RPS11 - 300W rack power unit with DC cable

RPSD2 - Dual supply combiner/monitor

1U 19" rack unit which allows two power units to connect to one console for redundant supply backup. Also provides local and remote DC rail LED monitoring.

The Integral Meterpod provides illuminated moving coil VU metering of the groups, L,R,M (or monitors, LR sidefill, listen wedge). Also additional PFL/AFL indicator.

GL4000-SL1 - SYS-LINK expander option

Circuit assembly and multi-pin connector system which can be fitted to the console to allow simple interconnection between two consoles so that one becomes the slave of the second by linking the audio busses and PFL/AFL system.

SYS-LINK interconnects using two standard 25way D-type cables to any other console fitted with the SYS-LINK system.

This option should be fitted only by your Allen & Heath agent or competent service personnel.

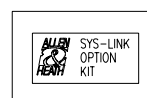
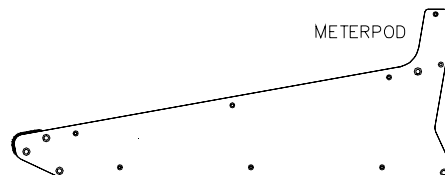
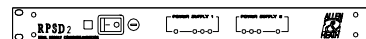
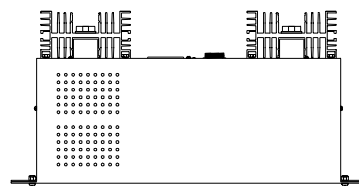
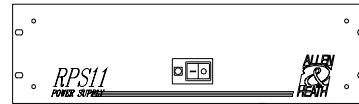
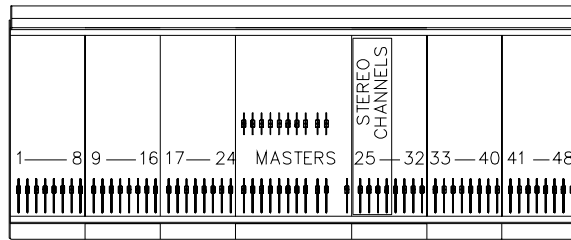

DIMENSIONS AND WEIGHTS

Dimensions shown in millimeters.

UNPACKED

	Width	Depth	Height	Wt (kg)
GL4000M-824	1166 (46")	748 (29")	285 (11")	47 (104lbs)
GL4000M-832	1421 (56")	748 (29")	285 (11")	57 (126lbs)
GL4000M-840	1676 (66")	748 (29")	285 (11")	67 (148lbs)
GL4000M-848	1931 (76")	748 (29")	285 (11")	77 (170lbs)
GL4000-8M	255 (10")	748 (29")	285 (11")	9 (20lbs)
RPS11	483 (19")	232 (9")	135 (3U)	10 (22lbs)
RPSD2	483 (19")	180 (7")	45 (1U)	6 (13lbs)

PACKED

	Width	Depth	Height	Wt (kg)
GL4000M-824	1702 (67")	900 (35")	390 (15")	82 (181lbs)
GL4000M-832	1702 (67")	900 (35")	390 (15")	91 (201lbs)
GL4000M-840	1950 (77")	900 (35")	390 (15")	100 (221lbs)
GL4000M-848	1931 (76")	900 (35")	390 (15")	129 (284lbs)
GL4000-8M	480 (19")	830 (33")	260 (10")	12 (26lbs)
RPS11	575 (23")	270 (11")	170 (7")	11 (24lbs)
RPSD2	520 (20")	260 (10")	115 (5")	6 (13lbs)

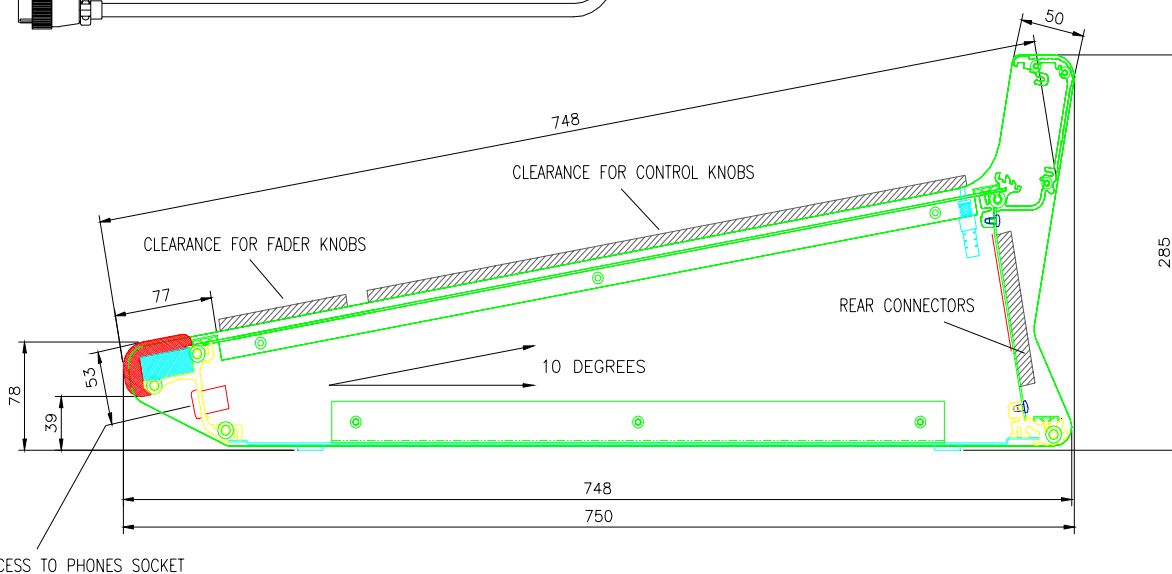
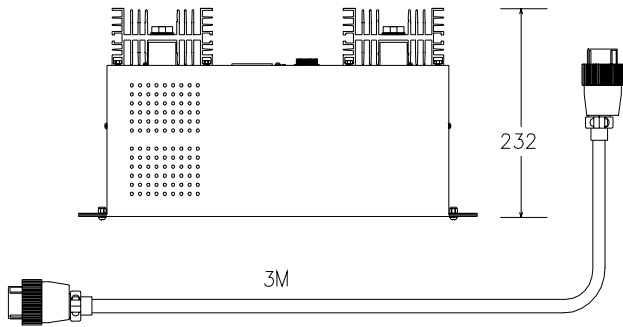
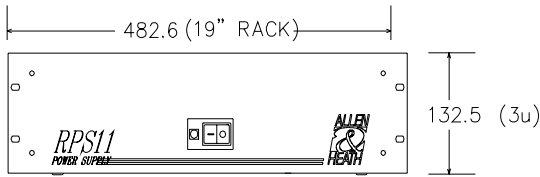
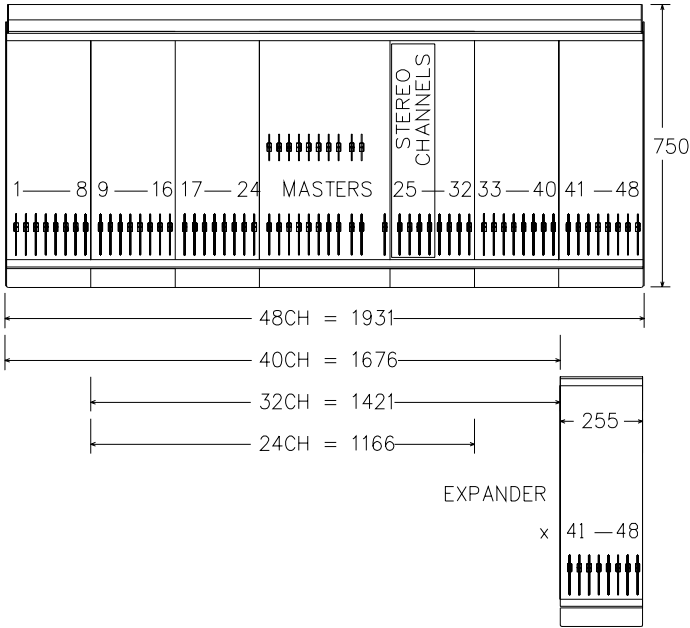

SPECIFICATIONS

0dBu = 0.775 Vrms Reference for high level equipment +4dBu = 1.23 V
0dBV = 1 Vrms Reference for low level equipment -10dBV = 310 mV
0VU meter reading = +4dBu at XLR outputs

INPUT GAIN

Mic/Line Input +6dB to +60dB variable
Mic/Line + Pad -14dB to +40dB variable
Line Input -14dB to +40dB variable
Stereo Line Input off to +10dB variable
2-track Return off to +10dB variable

MAXIMUM OUTPUT LEVEL

Main Outputs +27dBu into load of >600 ohm
Jack Outputs +21dBu into load of >2K ohm
Internal headroom +21dB

FREQUENCY RESPONSE

Measured 20Hz to 20kHz ref 1kHz
Mic to mix (+40dB) +0/-0.5dB
Line to mix (0dB) +0/-0.5dB

DISTORTION

THD + noise measured @ 1kHz +20dBu
Mic to mix (+40dB) 0.006%
Line to mix (0dB) 0.006%

CROSSTALK

Referred to driven channel @ 1kHz
Channel to channel > 100dB
Mute shutoff > 85dB
Fader shutoff > 90dB

NOISE PERFORMANCE

Measured rms 22Hz to 22kHz bandwidth
Mic EIN -128dB 150 ohm source
Line pre-amp (0dB) < -91dBu
Residual output noise < -98dBu (-102dB S/N)
Mix noise, nothing routed < -87dBu (-91dB S/N)
Mix noise, 24 channels routed < -81dBu (-85dB S/N)

METERING

Input meters 4 segment LED (signal, 0, +6, peak)
Mix meters 4 segment LED (signal, 0, +6, peak)
Output meters 12 segment LED
LED meter response peak reading
Peak indicators on 5dB before clipping
Signal indicators on -20dBu
Meterpod Illuminated VU moving coil meters

MODE SWITCHING

Protected underpanel mode switches set the console architecture according to the required application, for example FOH or stage monitor. Select these using a pointed object.



DIR OUT routes the channel direct out signal through the aux 10 pre/post selector and level control.



OUT REV swaps the matrix or LR2 output jack with the related aux XLR and insert. The control sections are not swapped. This can provide matrix outputs on XLR with inserts, or aux effects sends on jack as required.



TRIM ON routes the group output signal through a pre/post fader selector and level trim. This lets you record the groups independent of the subgrouping to LR and M.



MTX TO AUX Links the matrix mix into the aux mix to include aux sends from the groups, LR and M. Used for effects from the groups, and for quick monitor mixes.



GRP REV reverses the aux (small fader) and group (main fader) control sections. Also applies to LR. The outputs remain unaffected. This mode is used for stage monitoring.

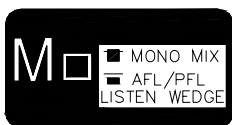

MONO MODE converts the mono output to the monitor engineers listen wedge. M AFL is disabled. The M mix still feeds the insert and matrix.

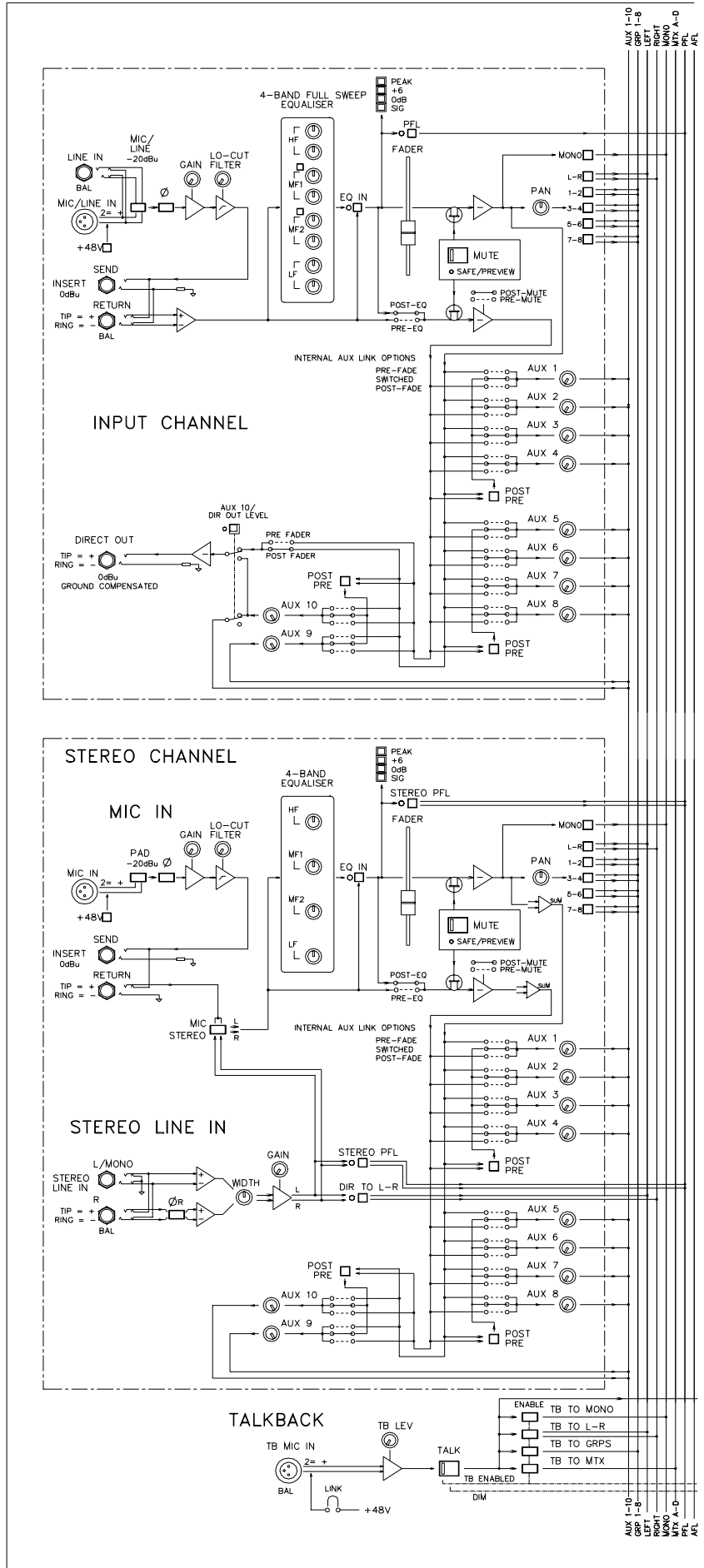

SYSTEM DIAGRAM

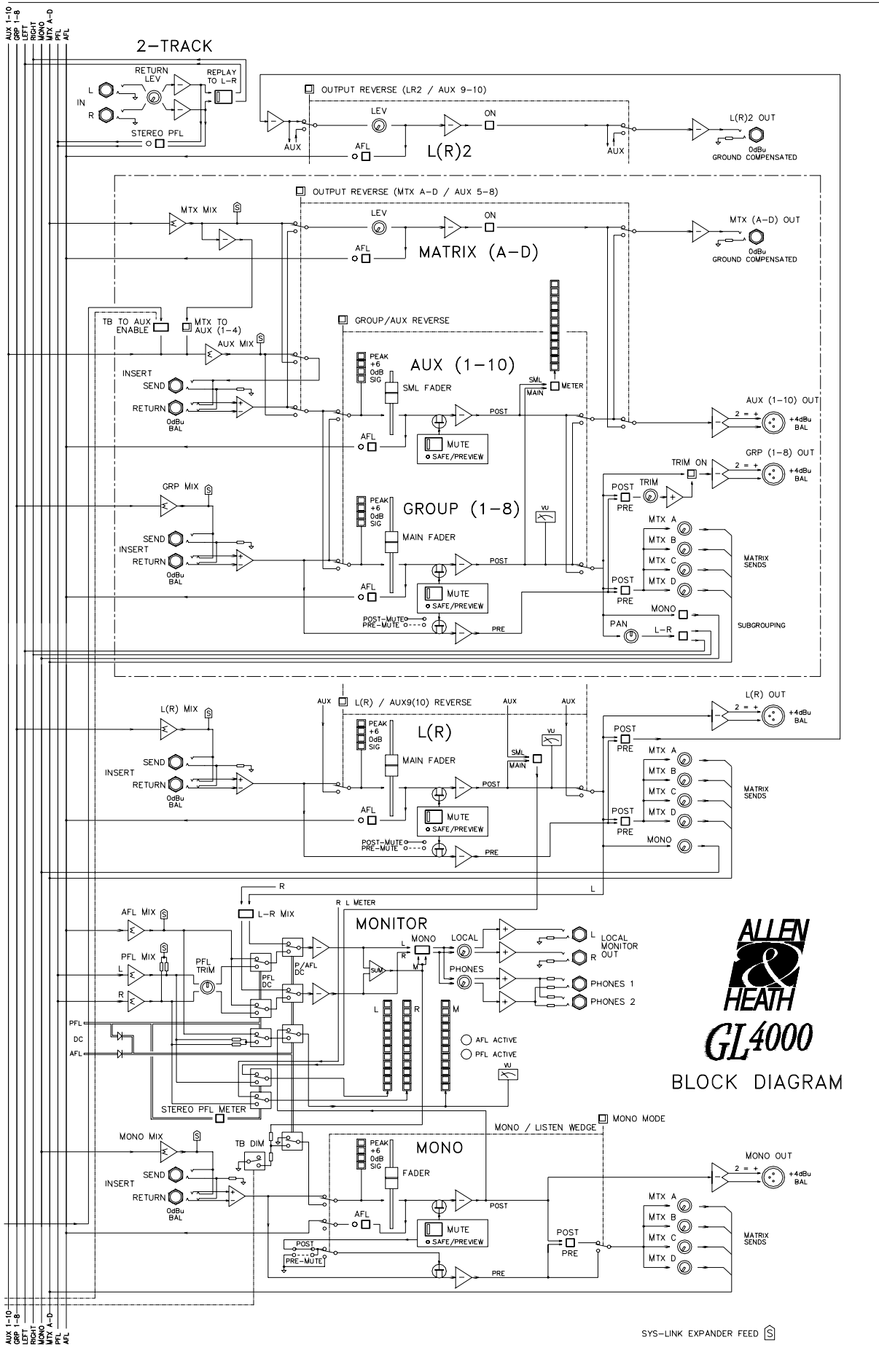

BLOCK DIAGRAM

CONNECTORS

Professional gold plated connector types are used to ensure continued reliable operation. All the console main inputs and outputs are balanced XLRs. All 1/4" jacks are 3-pole TRS for operation with balanced or unbalanced equipment. Inserts are provided on all channel inputs, and on Groups, L, R, Mono and all Aux outputs. Aux can be swapped with matrix and LR2 for XLR outputs with inserts

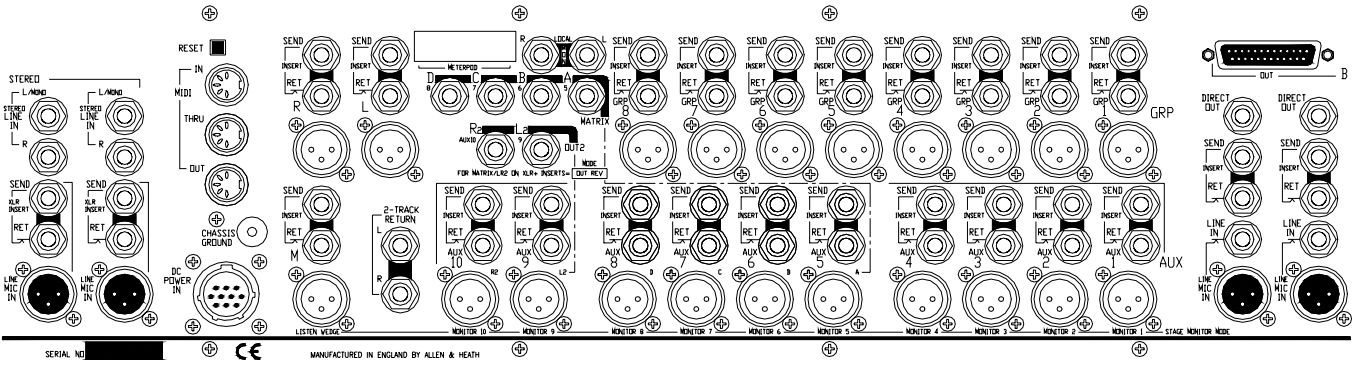

DIRECT OUTPUT

Provides a buffered signal from the channel, ideal for minimum signal path connection to multitrack recorders or local effects sends. Set post-fader, post-mute as standard. Can be switched through the Aux10 send control for pre/post fader selection and level trim with +6dB maximum boost.

3-pole 1/4" jack socket (tip = hot). Impedance balanced 50 ohm 0dBu line level for connection to balanced or unbalanced equipment.

INSERT SEND

Used to send the channel signal to external effects and signal processing equipment, post-pre-amp and pre-EQ.

3-pole 1/4" jack socket (tip = hot). Impedance balanced 0dBu 50ohm line level.

INSERT RETURN

Used to return the processed signal from external equipment into the channel audio signal path pre-EQ.

3-pole 1/4" jack socket (tip = hot). Balanced >10kohm 0dBu line level. (Stereo channel returns are unbalanced).

Mic/LINE INPUT

3-pin female XLR (pin 2 = hot). Electronically balanced. 74dB gain range. Mic impedance >2kohm, line >10kohm

Can be used for XLR line input when the LINE IN jack is left unplugged.

MONO CHANNEL LINE INPUT

3-pole 1/4" jack socket (tip = hot). Electronically balanced >10kohm.

STEREO CHANNEL LINE INPUT

3-pole 1/4" jack socket (tip = hot). Electronically balanced >10kohm. Plug into the Left input only for a mono line source.

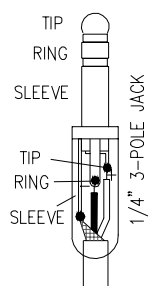
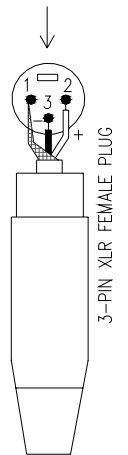
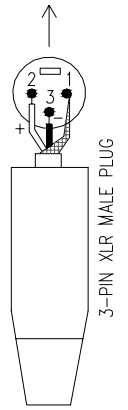
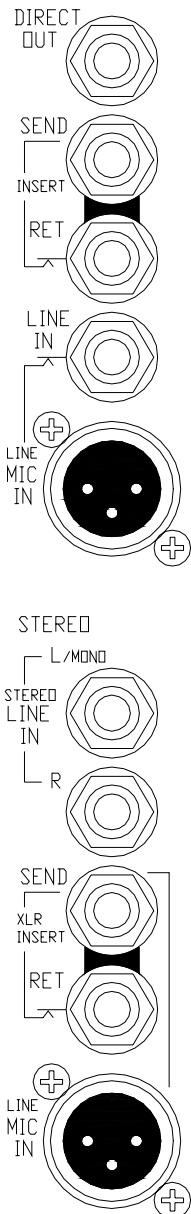

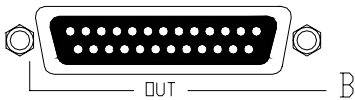

SYS-LINK EXPANDER OPTION

Available as a kit to be fitted to the console to expand the buses. Uses 4 25-pin D-type connectors (input and output A and B). Operates at -2dBu line level. Refer to your Allen & Heath agent for further details.

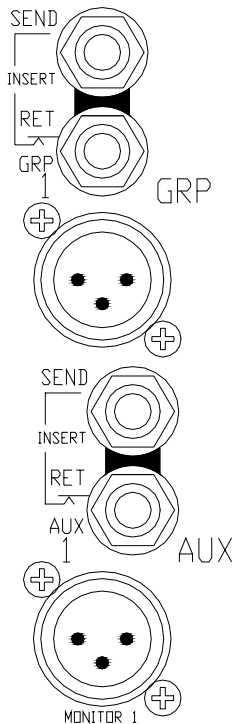

GROUP/Aux/L/R/M INSERT SEND

Used to send the output signal to external effects and signal processing equipment such as graphic equalisers, delays and compressors, post-mix amp and pre-fader.

3-pole 1/4" jack socket (tip = hot).
Impedance balanced -2dBu 50ohm line level.

GROUP/Aux/L/R/M INSERT RETURN

Used to return the processed signal from external equipment into the output audio signal path pre-fader and mix meter.

3-pole 1/4" jack socket (tip = hot). Balanced >10kohm -2dBu line level.

GROUP/Aux/L/R/M MAIN OUTPUT

3-pin male XLR (pin 2 = hot). Electronically balanced 75ohm. +4dBu line level, +27dBu maximum into 600 ohm load.

Capable of driving long cable runs without loss or interference.

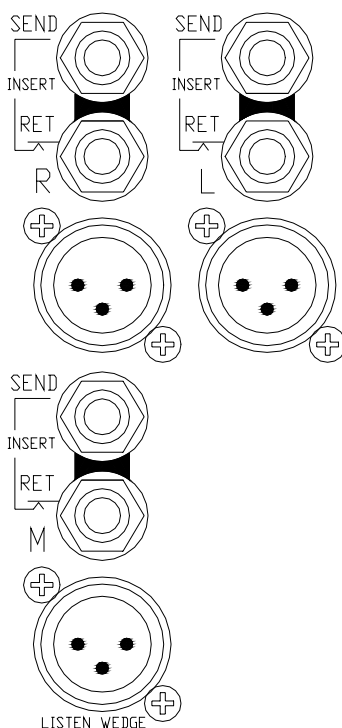

MODE SWITCHING

Set the underpanel mode switches for the intended console operation. Some of these affect the way the connectors work. For full details please refer to the BLOCK DIAGRAM.

OUT REV underpanel mode switch - The Aux XLRs and inserts can swap with the Matrix and LR2 output jacks for aux (effects) sends on jacks if required. This also provides matrix and LR2 outputs on XLRs with inserts for driving speaker systems.

MONO MODE underpanel mode switch - The Mono output becomes the engineers listen wedge monitor feed when the console is operated in on-stage monitor mode. However, the Mono insert remains with the mono mix.

MIX/AUX REV underpanel mode switch - Note that while the front panel control sections are swapped when the reverse mode switches are pressed, the signals always appear at their related connectors, ie. the connectors do not swap.

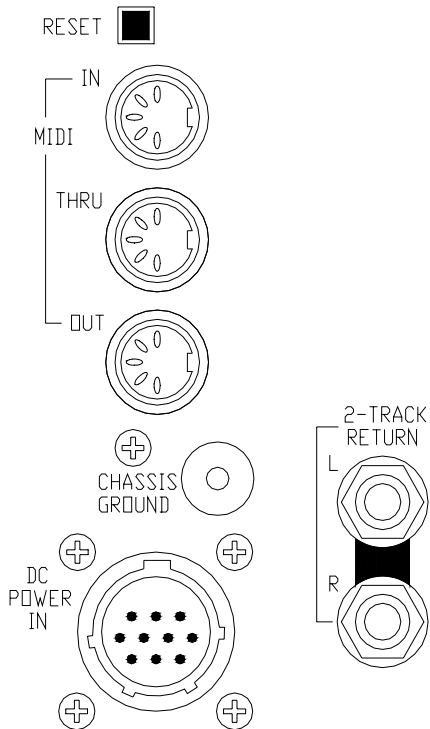
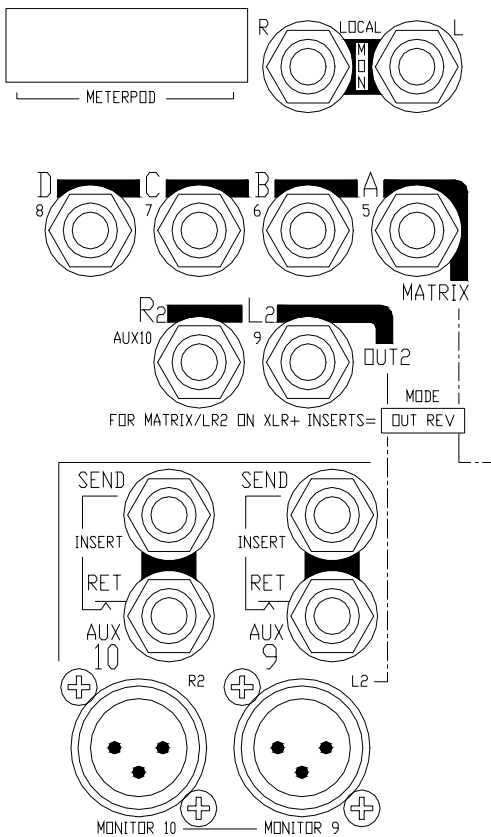

METERPOD CONNECTOR

Recessed 16-pin dual row header for connection to the meterpod.

LOCAL STEREO MONITOR

For connection to a stereo amplifier/speaker system for LR, AFL/ PFL monitoring local to the console.

3-pole 1/4" jack sockets (tip = hot). Impedance matched 50ohm 0dBu nominal line level.

HEADPHONES

Connections for 2 stereo headphones >8ohms. One connector is on the front panel, the other is concealed under the armrest.

3-pole 1/4" jack sockets (tip = left, ring = right).

MATRIX OUTPUT

3-pole 1/4" jack socket (tip = hot). Impedance balanced 50ohm 0dBu nominal line level.

Can swap with the aux output XLRs and inserts to drive long cable runs without loss or interference, and to insert external signal processing devices such as graphic equalisers and delays.

LR2 OUTPUT

Secondary LR output for 2-track recording, broadcast or additional speaker and zone feeds.

3-pole 1/4" jack socket (tip = hot). Impedance balanced 50ohm 0dBu nominal line level.

Can swap with the aux output XLRs and inserts to drive long cable runs without loss or interference, and to insert external signal processing devices such as graphic equalisers and delays.

2-TRACK RETURN INPUT

For connection to 2-track playback equipment such as cassette, DAT or CD players.

3-pole 1/4" jack sockets (tip = signal). Unbalanced 50ohm. +10dB maximum gain allows connection to low and high level equipment.

MIDI INTERFACE

Standard 5-pin 180° connectors for opto-isolated connection to other MIDI equipment. A mute processor reset switch is provided.

CONSOLE DC POWER INPUT

The console connects to a separate power supply unit via a 10-pin circular connector cable. Connect only the Allen & Heath power unit supplied with the console.

A chassis ground terminal post is provided. This connects to mains earth through the power cable.

EARTHING



The connection to earth (ground) in an audio system is important for two reasons:

1. **SAFETY** - To protect the operator from high voltage shock associated with the AC mains supply feeding the system, and
2. **AUDIO PERFORMANCE QUALITY** - To minimise the effect of earth (ground) loops which result in audible hum and buzz, and to shield the audio signals from external interference.

For safety it is important that all equipment earths are connected to mains earth so that exposed metal parts are prevented from carrying high voltage which can injure or even kill the operator. A solid, low impedance earth system is necessary to ensure that earths at different points in the system are kept at the same potential. A typical sound system includes amplifiers, signal processing equipment, microphones, musical instruments and much more in addition to the console, all of which require earth connection for safety and correct audio operation. Often this equipment is spread across the venue and interconnected by hundreds of metres of power and audio cables. It is recommended that the sound engineer check the continuity of the safety earth from all points in the system including microphone bodies, guitar strings, muticore cases, equipment panels ...

The same earth is also used to shield audio cables from external interference such as the hum fields associated with power transformers, lighting dimmer buzz, and computer radiation. Earth is also used for the signal 'return' when connecting to unbalanced equipment. Problems arise when the signal sees more than one path to mains earth. An 'earth loop' (ground loop) results causing current to flow between the different earth paths. A larger potential difference between these paths results in more current flow and so more audible noise. This condition is usually detected as a low frequency hum or buzz at mains frequency or its harmonics.

To ensure operator safety and trouble-free audio performance from your system we recommend the following :



- **Do not remove the earth connection from the power unit mains plug.** The console chassis is connected to mains earth through the power cable to ensure your safety. Audio 0V is connected to the console chassis internally. If problems are encountered with earth loops operate the audio 'ground lift' switches on connected equipment accordingly, or disconnect the cable screens at one end, usually at the destination. It is useful to carry ground lift cable adaptors such as short XLR male to female leads with pin1 disconnected.
- **Use a separate 'clean' mains outlet for the audio equipment** to prevent interference from other equipment such as lighting, stage machinery and vending machines. Ensure a good central 'star point' earth connection.
- **Avoid running audio cables next to mains, computer or lighting cables,** or near thyristor dimmer and power supply units. If unavoidable, cross these at right angles.
- **Use low impedance sources** such as 200 ohm or less microphones to reduce susceptibility to interference. The console outputs are designed to operate at very low impedance to minimise interference problems.
- **Use balanced connections where possible** as these provide further immunity by cancelling out interference that may be picked up on long cable runs. To connect an unbalanced source to a balanced console input, link the cold input (XLR pin3 or jack ring) to 0V earth (XLR pin1 or jack sleeve) at the console. To connect a balanced console output to an unbalanced destination, link the cold output to 0V earth at the console.
- **Use professional quality cables and connectors** and check for correct wiring and reliable solder joints.
- **If you are not sure ...** Have your system checked by a competent engineer, or contact your local Allen & Heath agent for advice.

CONNECTING THE POWER UNIT

Connect only the Allen & Heath power unit specified for the console. The standard unit for **GL4000** is the **RPS11**. This is an external 3U 19" rack mounted unit that connects to the console via the separate DC cable supplied. The **RPS11** is a low noise linear design that converts AC mains voltage to the DC voltages required to power the console. It also provides +48V phantom power for use with high quality powered microphones. The presence of AC mains voltage is shown on the power unit front panel neon indicator. The presence of the DC voltages is shown on the console power indicator LEDs. A second backup **RPS11** may be connected to the console through the optional **RPSD-2** dual supply combiner unit available from your Allen & Heath agent if required.

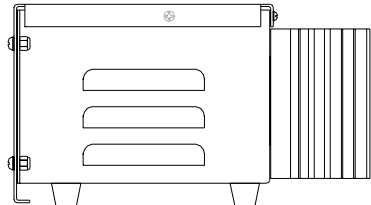
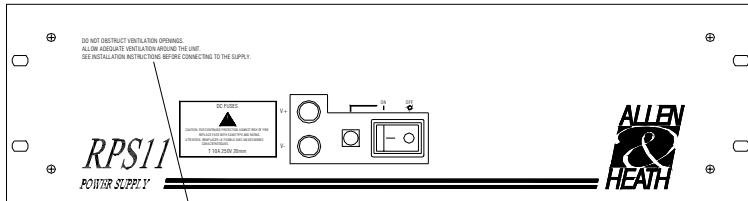

DO NOT OBSTRUCT VENTILATION OPENINGS.
ALLOW ADEQUATE VENTILATION AROUND THE UNIT.



WARNING - THIS APPARATUS MUST BE EARTHED.
WARNING: TO REDUCE THE RISK OF ELECTRIC SHOCK, DO NOT EXPOSE THIS APPARATUS TO RAIN OR MOISTURE



AVIS: RISQUE DE CHOC ELECTRIQUE - NE PAS OUVRIR.

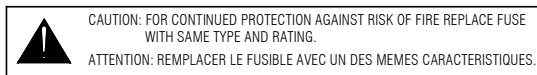

NO USER SERVICEABLE PARTS INSIDE

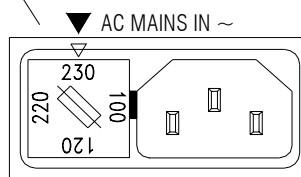
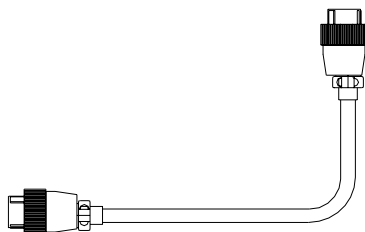
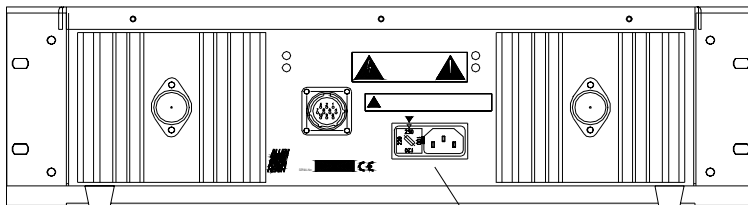

47-63Hz
320VA MAX
300W MAX

FUSE TYPE	AC SUPPLY
T 3.15A 20mm	220 - 240V~
T 5.0A 20mm	100 - 120V~

SAFETY WARNINGS !

Ensure that the warnings printed on the power unit (shown here) are followed.

Always switch the power unit off before connecting or disconnecting the console power cable.

It is normal for the power unit to dissipate heat. Do not cover the unit or position it on soft furnishings during operation. Do not position other equipment known to generate significant amounts of heat below the unit. It is recommended that rack units containing high power amplifiers and other heat dissipating equipment are fitted with cooling fans.

BEFORE SWITCHING ON !

Check that the voltage indicated on the fuseholder is correct for the mains voltage in your area.

Check that the mains IEC connector is fully inserted into the inlet socket.

Check that the DC power cable is correctly fitted to both the power unit and the console. The locking ring should be screwed in place.

It is recommended that audio power amplifiers are switched on last and switched off first to prevent possible damage to loudspeakers.

Check the system for safety earthing.

MATCHING THE SIGNAL LEVELS

For best performance it is important that the connected source signals are matched to the "normal operating level" of the console. Similarly the console outputs should be correctly matched to the operating levels of the connected amplifiers and destination equipment. If too high the signal peaks will be clipped resulting in a harsh distorted sound, and if too low the signal-to-noise ratio is reduced resulting in excessive background hiss and noise.

For best results operate the console with the meters averaging around '0' letting the louder passages peak into the 'yellow'. Reduce the gain if the red peak indicators flash. The **GL4000** produces a standard XLR output level of +4dBu for a meter reading of 0VU. It is advisable to adjust the power amplifier input gain or fit an attenuator pad if normal console operation results in an output level too high for the connected amplifier. Normal operation should result in fader levels around the '0' mark. Note that when reversed with the auxes the matrix and LR2 output level trims can be used to match the console to the amplifiers independent of the mix levels. Similarly the group output trims can be switched in to match levels.

The **GL4000** has an advanced PFL (pre-fade listen) / AFL (after-fader listen) and channel metering system to let you listen to and check the level of signals at different points in the signal path without affecting the main outputs. Use the channel **PFL** switches to set up the input **GAIN** controls to read an average '0'. Signal activity is always shown on the channel meters regardless of fader position. The green 'SIG' LED lights at -20dBu to indicate signal presence, the green '0' LED indicates normal level, yellow '+6' indicates normal peaks, and the red 'PEAK' LED warns of potential overload 5dB before clipping.

The mix meters above each output fader monitors the pre-fade mix level. You can run the mix 'hot' but reduce the channel fader levels if the red 'PEAK' LEDs flash.

LEVEL DIAGRAM

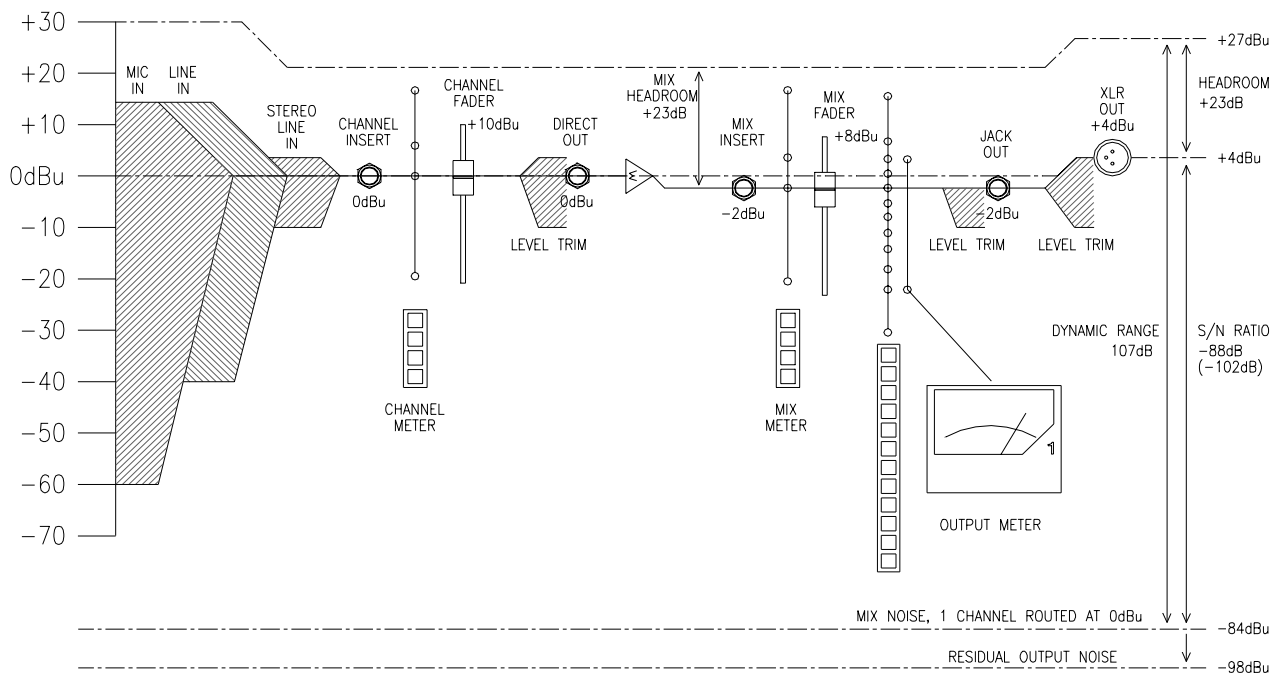

MONO INPUT

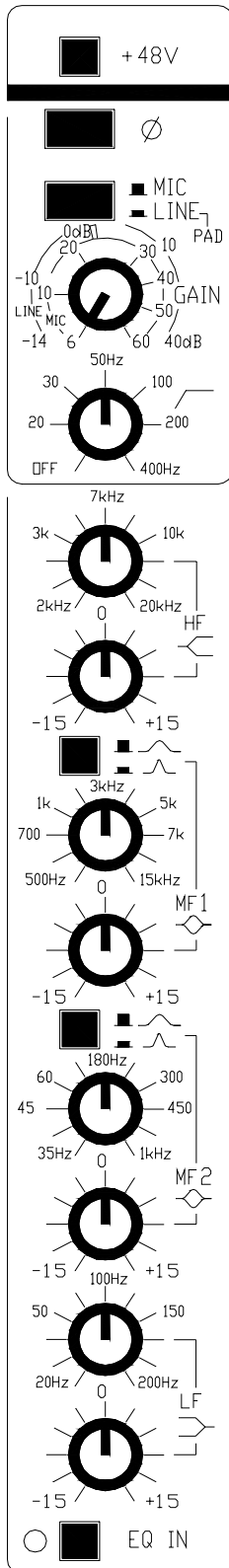

+48V - Feeds +48V to pins 2 and 3 of the input XLR for condenser microphones which require phantom power.

Plug the microphone in before switching +48V on or off. Use +48V only with balanced microphones and cables. No damage will occur when +48V is switched to balanced non-phantom powered transformer coupled dynamic microphones. However, always switch +48V off when connecting line or unbalanced sources.



PHASE REVERSE - Reverses XLR input pins 2 and 3 to correct for reverse wired cables or reversed phase signals. Can also be effective in minimising acoustic feedback between the microphone and loudspeakers in live sound mixing.

MIC/LINE (PAD) - Selects line input sensitivity when pressed, microphone when released. Note that with the line jack unplugged the switch acts as a 20dB pad for high output microphones or line input on XLR.

GAIN - Use this control with the MIC/LINE switch to adjust the channel input sensitivity to match the connected source (-60 to +14dBu) to the console operating level (0dBu). The gain should be set so that the channel meter reads an average '0'.

LO-CUT FILTER - Reduces low frequency source noise such as microphone proximity popping, stage noise and transport rumble. Can be used to clean up sounds that do not have much bass content such as vocals (around 150Hz), separate out the top end of a drum kit (400Hz), reduce the handling noise of acoustic instruments, and so on. Select the required cut off frequency by sweeping from fully anticlockwise (filter off) to the maximum 400Hz. Setting the cutoff to 50Hz will have little effect on most program material but will protect the low frequency speaker drivers. The response drops by 12dB per octave below the cut off frequency.

EQUALISER - This provides separate, simultaneous control of 4 frequency bands. Each band may be boosted or cut by up to +/- 15dB centred on the selected frequency which may be swept across a wide range. Use the equaliser to correct for tonal deficiencies in the source such as acoustic resonances or poor microphone response (corrective EQ), or to change the tonal balance, for example to brighten up a guitar so it cuts through the mix (effective EQ). You may need to adjust the input GAIN control when using excessive amounts of EQ to compensate for the change in overall signal level.

HF and LF affect the high (treble) and low (bass) frequencies respectively. These have a shelving response which means that all frequencies beyond the selected frequency are affected.

MF1 and MF2 affect the upper and lower mid frequencies respectively. These have a peak/dip (bell shaped) response which means that the maximum boost or cut occurs at the selected (center) frequency. The MF1 and MF2 bands overlap for additional cut or boost when required or to provide a tailored frequency response to suit any application. The sharpness of the curve is selected using the **Q** switch to a Q of either 1 (wide band) or 2.4 (narrow band). Use wide band when you want to add presence or warmth to the sound. Use narrow band to control problem frequencies for example when notching out acoustic resonances.

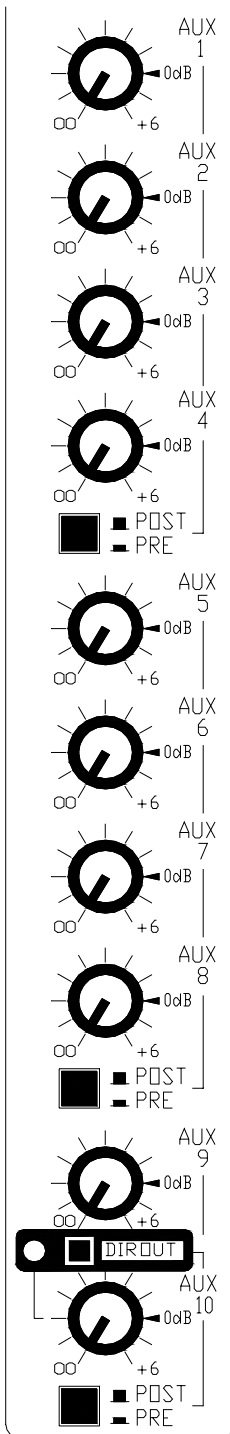

AUXILIARY SENDS - Route the channel signal to one or more of 10 auxiliary send busses. These are independent from the main outputs and may be used for effects sends and monitor mixes. The sends are grouped 1-4, 5-8, and 9-10. Each group may be selected pre or post channel fader. A further 6dB of boost above 0dB normal channel level is available on the send control.

Use **post-fade** for effects sends such as reverb. The amount of signal sent to the effects unit follows the fader level and mute switch. The processed ("wet") signal returned to the mix through the return channel is therefore in proportion to the direct ("dry") signal from the fader to the mix.

Use **pre-fade** for monitor sends such as to on-stage monitor, backstage, orchestra pit, and musicians cue speakers. The amount of signal in the monitor mix is independent of the fader level. Pre-fade sends are post-EQ, post-mute as standard. (may be configured pre-EQ or pre-mute by setting internal links).

DIRECT OUT - The 0dBu post-fade channel signal is available at the DIR OUT jack socket. For pre/post selection and independent level control select the underpanel **DIR OUT** mode switch. The 9-10 pre/post switch and aux 10 send control now affect the direct out signal. Select POST for an effects send dedicated to that channel (local effect) without tying up a complete aux buss. Select PRE for a multitrack recording send with independent level control.

MUTE - When illuminated the channel signal is turned off (muted). This affects both pre and post fade signals unless the pre-fade aux has been internally configured pre-mute. The silent action mute element can be controlled by the switch, mute groups, mute patches or via MIDI. The green SAFE/PREVIEW LED indicates if the channel has been made 'safe' so that it is not affected by the mute groups, patches or MIDI. It is also used when previewing or editing the groups and patches.

ROUTING and PAN - The PAN control positions the channel signal in the stereo mix. The post-pan signal may be routed directly to the L-R mix or to the groups in odd/even pairs. The groups may be used to feed additional outputs or recording tracks, or for **subgrouping** combinations of channel signals to the mix so that the overall level of the group can be controlled without affecting the balance between the signals, for example the drum kit mics. The pre-pan signal may be routed to the MONO output independent of the stereo positioning.

METER and PFL - The peak reading meter displays the channel signal pre-fader. Use this to monitor signal presence and level. The signal should average around '0' with the loudest peaking at '6'. If the red PEAK light flashes the signal level is too high (5dB below clipping) and should be reduced using the GAIN control to prevent possible overload distortion. Press PFL to listen to the pre-fade signal on headphones or engineers monitor without affecting the main outputs.

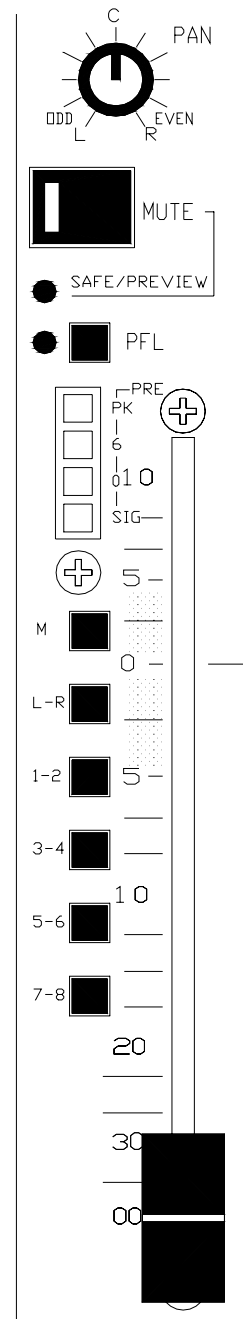

STEREO INPUT

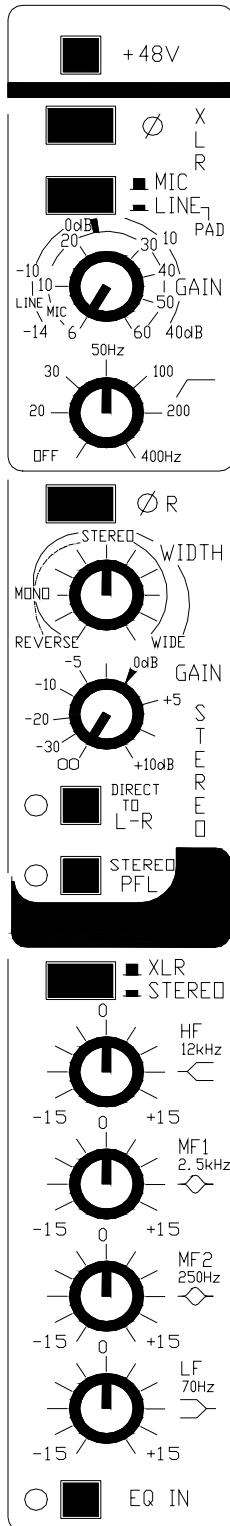

The stereo channel has two independent input sections: **XLR IN** for mono microphone or line input, and **STEREO LINE IN** on jacks for sources such as stereo keyboards, voice modules and effects returns. When using the channel as a mono XLR mic/line input the stereo line input can be independently routed to L-R for a stereo effects return or additional line input. The XLR inputs on adjacent channels can be patched into a stereo line when using stereo or paired microphones.

XLR MIC/LINE INPUT - This section is the same as the mono channel input except that it has only the XLR input for both mic or line. It uses the same wide ranging balanced pre-amp stage and includes the swept lo-cut filter and insert. Refer to the MONO INPUT section for a detailed description of these controls.

STEREO LINE INPUT - The left/mono and right inputs feed a balanced pre-amp stage with **GAIN** variable from fully off to +10dB boost. Press **ØR** to reverse the phase of the right input signal to correct phase differences between the inputs. the **WIDTH** control is normally set to the centre detented position for normal stereo. Turn anticlockwise to narrow the stereo image until it becomes mono. Continue anticlockwise to open up the stereo image but with left and right reversed. Turning clockwise from centre accentuates the stereo effect by producing a phase enhanced "wide" image. Press **PFL** to listen to the stereo signal on headphones or local monitor without affecting the main outputs.

DIRECT TO L-R routes the stereo line signal to L-R independent of the main stereo channel which you may be using as a mic/line XLR input. The **GAIN** control adjusts the level to L-R. **PFL** lets you check the post-gain, post-width stereo signal independent of the main channel **PFL**.

XLR/STEREO selects the input source to the main stereo channel. When pressed the stereo line input is selected, when released the XLR mic/line input is selected.

EQUALISER - This provides separate, simultaneous stereo control of 4 frequency bands. Each band may be boosted or cut by up to +/- 15dB. **HF** and **LF** have a shelving response and affect the high (treble) and low (bass) frequencies respectively. **MF1** and **MF2** have a peak/dip (bell shaped) response and affect the upper and lower mid frequencies respectively. **MF1** is centred on 2.5kHz (presence) and **MF2** is centred on 250Hz (warmth). Careful use of the equaliser can go a long way to brightening up the sound of your stereo instruments, or tuning out the noise characteristic of many lower cost effects units.

AUXILIARY SENDS - 10 aux sends are provided. These work in the same way as the mono channel. Note that the left and right signals are combined as mono aux sends. No direct output facility is available.

ROUTING, PAN, METER and PFL - These are the same as on the mono channel. When a stereo input is selected **PAN** acts as a balance control to adjust the level of the left and right signals relative to each other. The meter indicates the pre-fade left and right signals combined. **PFL** operates in stereo so that you can hear the image of the stereo source and check the relative levels on the L and R meters.

M-S STEREO MICROPHONES

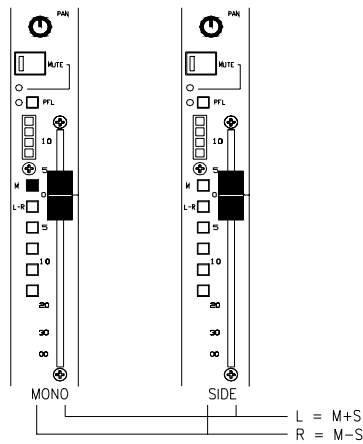
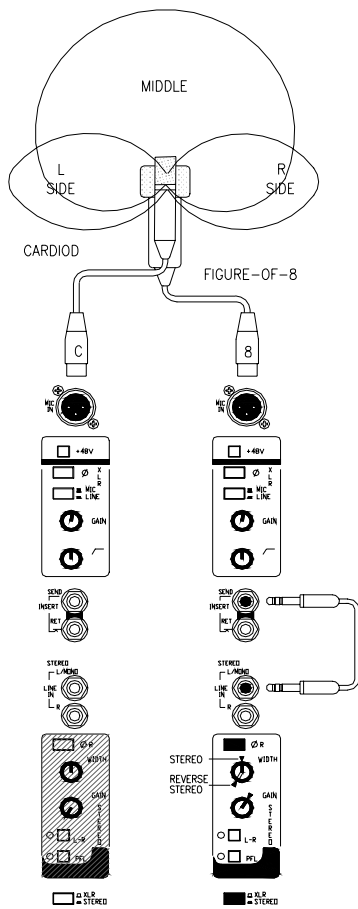
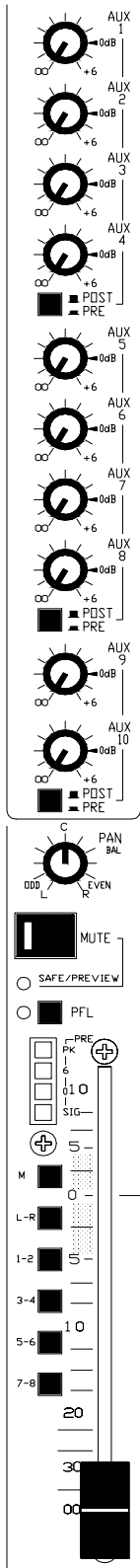

The M-S stereo configuration is often preferred when simultaneous mono feeds are derived from the stereo signal. Here, a cardioid and a figure-of-8 mic are positioned on the same stand. The cardioid picks up the "middle" (mono) signal, and the figure-of-8 the "side" (stereo content). Stereo is extracted from the mic signals by producing sum and difference channels. When combined the stereo content is cancelled out leaving true mono. Balance the two faders to achieve the desired image.

STEREO MICROPHONES

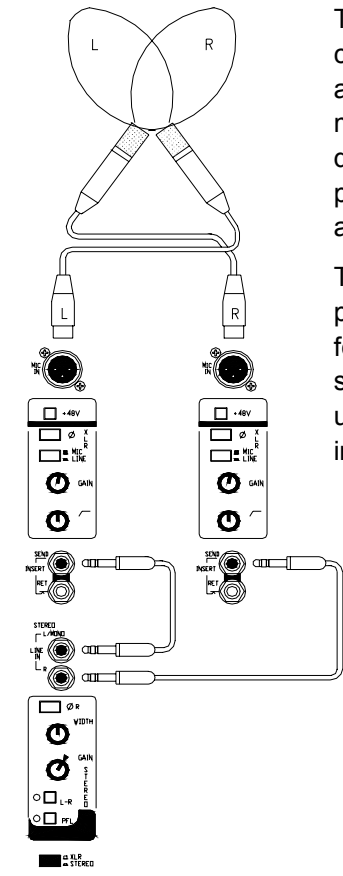

This example shows two cardioid microphones arranged as an X-Y coincident pair. This minimises the phase differences which can cause problems when the mics are arranged as a spaced pair.

The mic input stages are patched into a stereo line input for single fader control. The second stereo channel may be used for an independent line input.

ABOVE AND BELOW MICROPHONES

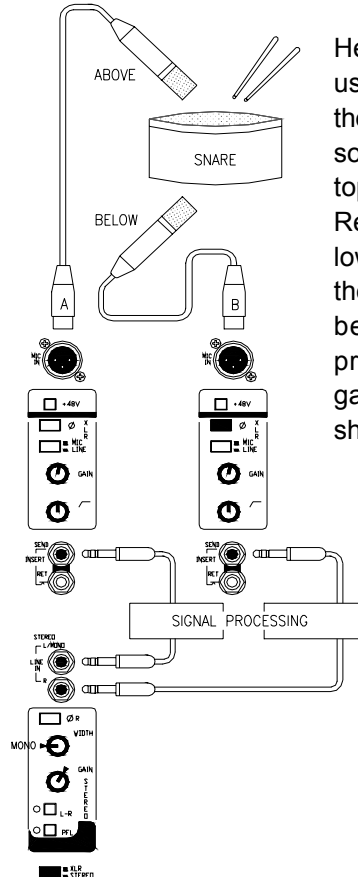

Here, two microphones are used on the snare drum to get the best balance between stick sound and skin resonance on top, and snare sound below. Reversing the phase of the lower mic can compensate for the opposite skin resonance between the mics. Signal processing such as noise gates can be patched in as shown.

GROUP

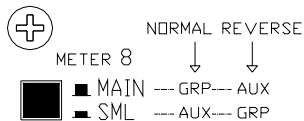
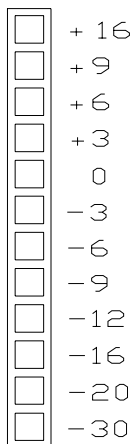
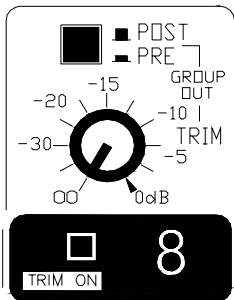
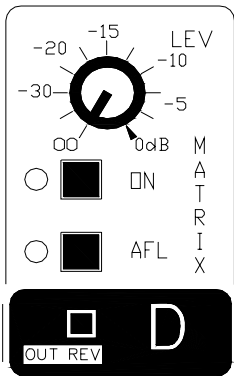

MATRIX MASTER - Controls the output of the matrix mix. Adjust **LEV** to trim the output level to match the connected equipment. **ON** switches the output on or off, ideal for checking the effect of individual or combinations of speakers in a multispeaker system. **AFL** lets you monitor the signal post level trim, post insert, but pre **ON** switch.

OUTPUT REVERSE - This underpanel mode switch reverses the matrix output jack with the related aux output XLR and switches the aux insert out of the aux signal path and into the matrix path. This gives the matrix a balanced XLR for driving the long cable runs to the amplifier racks, and an insert for plugging in processing devices such as graphic EQ and delay units. You could also use this to provide aux outputs on jack, often more convenient when connecting to some of the lower cost effects devices. Note that only the connectors are reversed. The matrix and aux control sections are not affected.

TRIM ON - With this underpanel mode switch in the normal up position the group output is fed post fader to the output XLR. Press the switch to insert a level trim control in the group output signal path. This does not affect the level of the subgrouping to LR and M. You can also select whether the group output is sourced pre or post the group fader. This facility is most useful when using the group outputs for recording. The recording can be adjusted independent of the subgrouping and faders.

METER - 12 segment, 3 colour peak reading meter. Each meter can be switched to monitor either the main fader signal (normally group) or the small fader signal (normally aux). The switch does not affect the optional VU meterpod which always follows the main fader signals.

AUX MASTER - Provides fader control of the aux send output. Includes a pre fader aux meter to display signal activity and warn of potential mix overload. **AFL** monitors the post insert, post fader signal. You can listen to the effect of graphic EQ typically inserted in a stage monitor signal path. The **MUTE** switch is part of the console mute grouping and automation system and includes preview and safe.

GROUP REVERSE - Press this underpanel mode switch to reverse the aux and group control sections. This configures the group for stage monitor operation giving you auxes on the main faders. The groups are still available on the small faders. The aux and group output connectors are not affected.

TALKBACK TO AUX - This switch enables talkback to the related aux mix. When selected, pressing the large TALK switch routes talkback to the aux. When not selected, pressing TALK does not affect the aux.

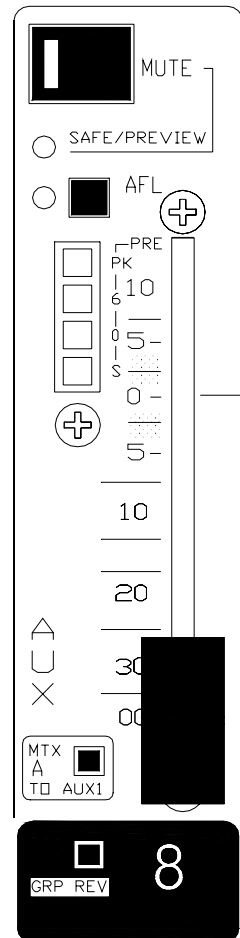

THE CONSOLE MATRIX - The **GL4000** includes a versatile 11 x 4 output matrix. This comprises four independent outputs each with level control, ON switch and AFL monitoring. Each matrix mix is created from the desired combination of group (x8), L (left), R (right) and M (mono) signals. The level of each source is adjusted using the matrix SEND controls above the main faders in much the same way as the channel aux sends are used. The output is selectable to a TRS jack or XLR with insert.

Typical applications of a matrix include:

Additional speaker feeds for zoning and delay fills - The mix may not be exactly the same as that feeding the LR speakers. For example, the vocals may be boosted to aid clarity for listeners at the rear of the venue. It is common to insert a delay unit to compensate for acoustic delay if the speaker is positioned a significant distance from the stage. Some EQ may also be required.

Recording - It is seldom adequate to record live to 2-track from the LR mix. Typically the LR house mix is 'vocal heavy' as much of the instrument sound is heard acoustically and the PA is used to supplement the sound. Use two matrix outputs and create a more balanced mix for the recording using the matrix sends. Here, the 'backline' sound can be boosted on the related group send controls.

Video and Broadcast feeds - The mix may be balanced and stereo image set as required without affecting the PA mix. Often a mono broadcast feed is asked for. Set this up by mixing in equal amounts of the L and R mix.

MATRIX SENDS - These route the group signal to one or more of 4 matrix mix busses. The source may be selected pre or post group fader. The level may be adjusted from off to +6dB boost. The normal '0' level is marked on the control dial. The matrix source is always fed from the groups even if GRP REVERSE is selected.

MATRIX TO AUX LINK - Aux masters 1 to 4 include this underpanel mode switch. When pressed this links the related matrix mix (A to D) to the aux mix. This unique feature lets you extend the aux mix across the master section so that monitors and effects can be created from the groups, L, R and M, pre or post fader. Similarly, the aux output may be used as a matrix created from the master section and with additional feeds from the channels.

GROUP MASTER - The group mix is normally controlled using the 100mm main fader. If GRP REVERSE is selected this section controls the aux mix. A pre fader group meter is included to display signal activity and warn of mix overload. The **MUTE** switch is part of the console mute grouping and automation system and includes preview and safe. **AFL** monitors the signal post insert and post fader.

SUBGROUPING - The post fader group signal can be routed to the main L-R and/or M outputs by pressing the switches to the left of the fader. **PAN** adjusts the position of the signal between L and R. Routing a combination of channel signals to a group and then routing the group to the main mix lets you control the level of the combined signals with a single fader. Routing and panning to a pair of groups and then panning them L and R lets you subgroup in stereo. Subgroups are typically used for drum kits, vocals, stage mics, backline instruments etc.

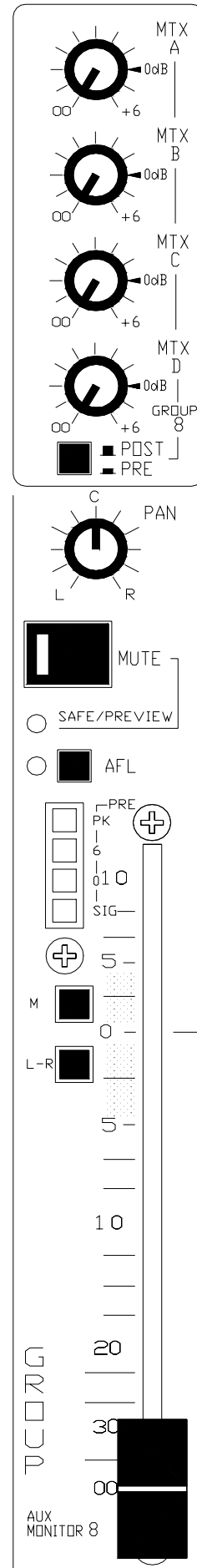

LR

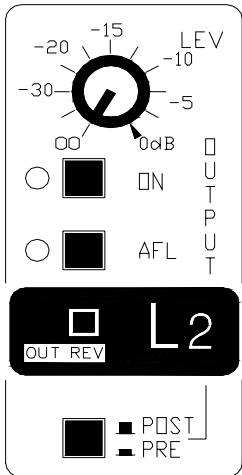

THE CONSOLE LR AND LR2 OUTPUTS - In addition to the main L and R outputs the **GL4000** includes a secondary pair of outputs called L2 and R2. These follow the LR mix and may be selected either pre or post LR faders. As with the matrix outputs an **OUTPUT REVERSE** switch is included on each to swap the L(R)2 jack output with aux 9(10) XLR and to switch in the insert. Use this when you need to drive long cable runs, interface with standard XLR multicores and cables, or insert EQs, delays or other signal processors.

Typical applications include:

Additional stereo speaker feeds - For zoning, dual speaker systems and delay fills.

2-track Recording - For an independent feed from the LR mix, pre or post fader. Can also be used as a simple stereo broadcast feed.

L(R)2 MASTER - Selects and controls the L and R secondary outputs. Adjust **LEV** to trim the output level to match the connected equipment. **ON** switches the output on or off. **AFL** lets you monitor the signal post level trim, post insert but pre ON switch.

METER - 12 segment, 3 colour peak reading meter for L and R. Each meter can be switched to monitor either the main fader signal (normally L and R) or the small fader signal (normally aux 9 and 10). The switch does not affect the optional VU meterpod which always follows the main fader signals. The L and R meters can be switched using **STEREO PFL METER** to be interrupted by stereo PFL when selected.

L(R) MASTER - The LR mix is normally controlled using the 100mm faders. If **L(R) REV** is pressed the main faders follow the aux 9(10) signals and L(R) is available on the small faders. As with the groups: automated **MUTE**, pre fade mix meters, matrix sends and **AFL** are available.

L(R) TO MONO - The required amount of post fade L and R signal may be added to the M mix using these controls. You can create a quick mono output by mixing in equal amounts of L and R signal. You can also use L and R as additional subgroups to M.

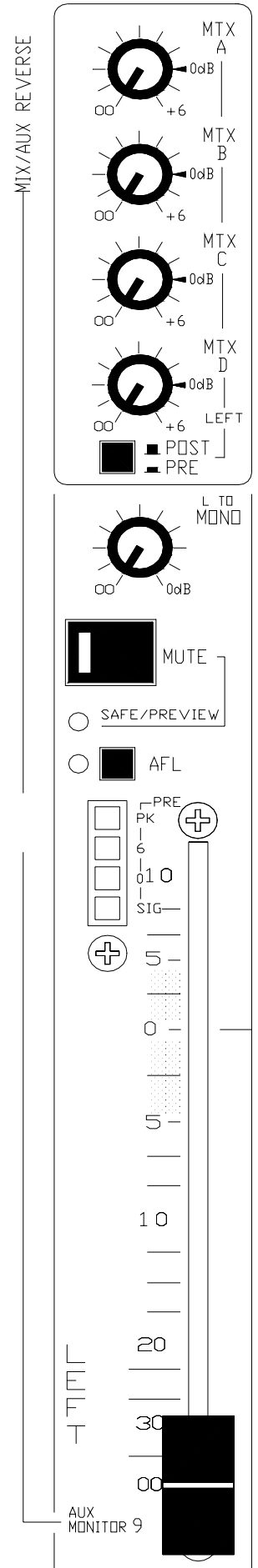
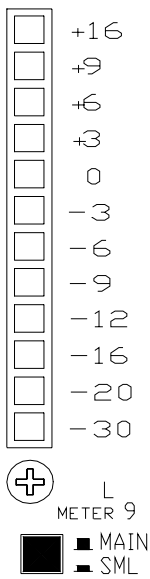

MONO

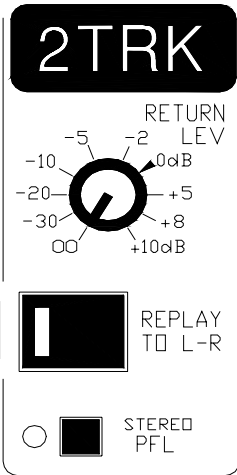

2-TRACK STEREO RETURN - The incoming level can be trimmed from OFF to +10dB gain and routed direct to the LR mix for intermission or recording replay. Monitor the signal post LEV trim and pre REPLAY switch using **STEREO PFL** which automatically overrides the signal in the headphones and local monitor.

AFL/PFL INDICATORS - Large red LED indicators show when AFL or PFL is selected.

MONO METER - The MONO METER follows the post fade mono mix signal and is interrupted to show the AFL or PFL signal when selected.

PFL INTERRUPTS AFL - Pressing a PFL switch automatically overrides any selected AFL. This is most useful in stage monitoring when you may wish to continually monitor a selected stage mix using AFL. You can quickly check the channel signals by pressing PFL which cuts out the stage mix monitor signal while selected.

STEREO PFL METERING - Press the switch above the mono meter to allow any selected PFL to override the LR meters. These meters will display PFL in stereo if a stereo source is selected. If a mono source is selected both meters display the mono PFL signal.

STEREO/MONO COMPATIBILITY - You can display and listen to the mono compatibility of your stereo sources by selecting a stereo PFL. The L and R meters display the signal in stereo. The M meter displays the LR sum (mono) signal. A low M meter reading compared with LR meters can indicate a phase problem between L and R. This can be checked and corrected using the stereo channel **ØR** switch. You can listen to the signal in mono by pressing the **STEREO/MONO** switch in the console monitor section.

TALKBACK - Plug in a microphone and adjust **TB LEV** to talk to the outputs you select on the talkback assign switches. An internal link assigns +48V phantom power if required. Talkback will be activated to the selected destinations when you press the large **TALK** button. If any destination is selected the green LED in the TALK button will light, useful if you want to be sure that the talkback system is made 'safe' during the show. You can talk to the 10 auxes in any combination, to the M mix, LR mix, all 8 groups together, and all 4 matrix together.

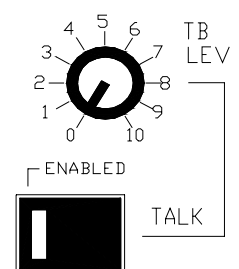
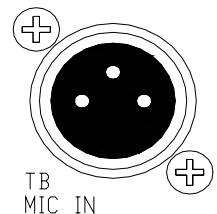
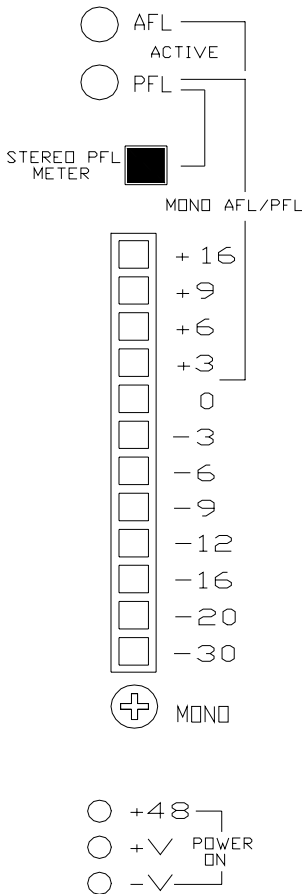

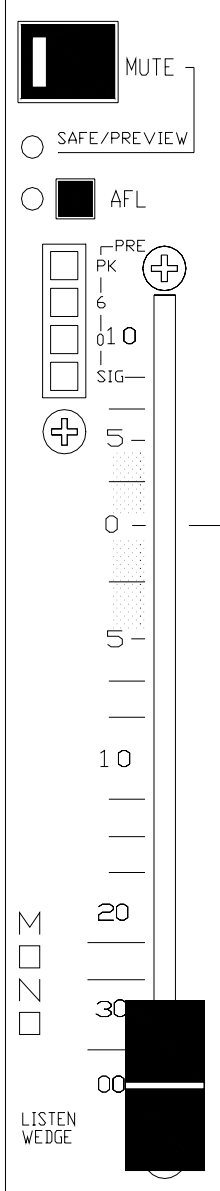
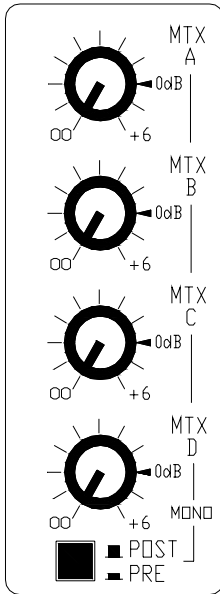

THE MONO MIX - The *GL4000* includes an independent mix buss for the M (mono) output. Each channel and group can be routed direct to this buss by pressing the related **M** routing switch. The signal is sourced pre PAN control so that the mono mix is not affected when the stereo mix image is adjusted. The M output can be a different mix to LR. If you want the mono output to be the sum of the L and R mix then use the **L(R) TO MONO** controls to mix L and R to M.

Some typical applications of the Mono output:

Centre speaker feed - To fill out the sound between the left and right speakers. This is usually positioned to benefit the audience nearest the stage.

Mono PA system - Here, the L and R mix can be used as additional subgroups or for a separate stereo recording.

Sub bass feed - To drive a speaker designed to reproduce the very low frequency sounds in multi speaker systems.

MATRIX SENDS FROM MONO - The mono buss signal may be mixed into matrix A to D by adjusting the matrix send controls. The signal is sourced pre or post the M fader by selecting the **POST/PRE** switch.

MONO MASTER - The M mix is controlled using a 100mm fader. As with the groups and LR: automated **MUTE**, a pre fade mix meter, matrix sends, insert and **AFL** are available.

STAGE MONITOR MODE - Unique to Allen & Heath consoles, an underpanel mode switch determines how the Mono section operates. In the normal up position it provides a conventional mono buss output for front-of-house applications as described above.

When pressed, the Mono section is reconfigured as the stage monitor engineers listen wedge control. The Mono output becomes silent until an AFL or PFL is selected. Pressing PFL automatically overrides any selected AFL. The Mono section AFL switch is disabled in monitor mode. Pressing AFL monitors the output post insert and post fader. You can hear the effect of any EQ or signal processing inserted into the outputs. The listen monitor is controlled using the 100mm MONO fader with MUTE switch.

Connect the Mono output to an amplifier driving the engineers monitor speaker. It is best to use a speaker identical to those used for the stage monitors, usually wedge shaped (hence the term listen 'wedge'). You would not normally plug an EQ into the listen monitor as it is best to hear the selected listen source exactly as the performer hears it on stage.

Pressing TALK dims the listen output by 20dB to prevent possible acoustic feedback between the local speaker and talkback mic.

LAMP CONNECTORS - Two top panel 4-pin XLR connectors are provided for connection to gooseneck lamps. It is recommended that these are the standard 12V 2.5 watt type.

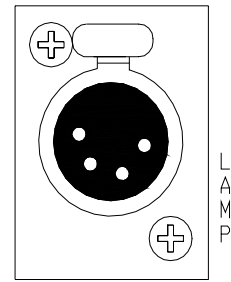

THE CONSOLE MONITOR - The **GL4000** offers a comprehensive signal monitoring system. Apart from the extensive metering facilities there is a monitor section which operates independently of the main outputs.

PFL TRIM - Adjust the trim control for the most comfortable listening balance between AFL and PFL levels in the headphones, local monitor or listen wedge. It is typical that the AFL levels are generally quieter than PFL in live sound mixing due to the fader settings in the mix. Normal level is indicated at the centre detented '0' mark. You can reduce the listening level by up to 12dB, or boost it by up to 6dB. Adjusting the trim does not affect the PFL meter readings which always display the actual signal level.

HEADPHONES MONITOR - You can plug in up to two headphone sets, one on the top panel and the other safely protected under the armrest. The headphone monitor has its own **PHONES LEV** volume control.

LOCAL MONITOR - A separate stereo monitor output is provided for connection to a local amplifier/speaker monitor system. This is usually positioned on or near the console so that the engineer can monitor the signals on speakers rather than headphones. The volume is independently controlled using **LOCAL LEV**. The local monitor doubles as a studio monitor in the recording environment.

L-R MIX - Press this switch to listen to the post fader LR main mix. In live sound mixing it is often preferred to turn off the LR monitoring until required. This prevents distracting audio spill from the headphones or local monitor. Of course, pressing any AFL or PFL activates the monitors as normal.

STEREO/MONO - Press this switch to listen to the selected monitor source in mono (L+R sum). This can help identify problems with the mono/stereo compatibility of the signal.

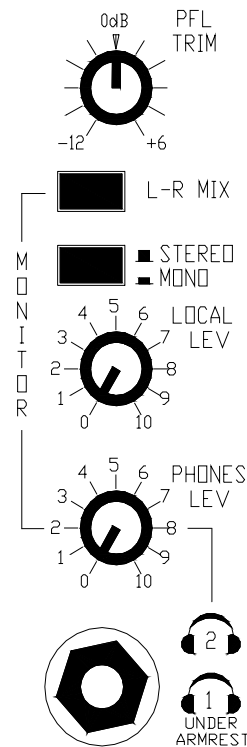

THE MUTE SYSTEM

Each **GL4000** input channel, group, aux send and main output (L,R,M) is provided with a mute switch. This turns the audio signal on or off.

The **GL4000** provides a 'soft' mute system controlled by a built-in microprocessor which gives far greater control and versatility than the conventional systems found in other consoles. A ramped FET audio element on each channel provides silent muting under control of the microprocessor. The red LED in the mute switch always indicates the status of the channel (illuminated = muted, off = not muted). A green **SAFE/PREVIEW** LED under each mute switch indicates which channels have been made 'safe', or which channels are selected within a group or patch.

OPERATIONAL FEATURES

MANUAL MUTING - Press a mute switch to turn a channel on or off. The switch cap illuminates if the channel is muted. You can also turn off (clear) or turn on (set) all the console mutes with a single key press..

8 MUTE GROUPS - Combine selected mutes under control of a master pushbutton. Includes a preview function to check group settings before selection. Individual channels can be made 'safe' so that they are not affected by the groups. If not used the group section can be disabled to prevent accidental operation.

128 MUTE PATCHES - Store and recall the console mute settings in numbered patches. Includes 3 digit display, preview function, channel 'safes', and disable.

MIDI INTERFACE - In, out and through sockets to interface with external sequencers, effects and control devices. Includes MIDI dump to archive and recall console settings.

QUICKSOLO - Check the contribution of individual signals within the main mix 'in place' by pressing the associated mute switches. Includes a separate 'safe' facility so that selected channels are not muted when solo is activated. A two key 'press and hold' prevents accidental operation. The last solo setting can be recalled for instant comparison with the mix. QuickSolo can be disabled if required.

POWER UP AND POWER DOWN

The mute settings are remembered when power is removed from the console. A power down circuit detects falling voltage and writes the settings to non-volatile memory. On power up these settings are restored. The mute group, patch, channel safes, and mode settings are held in similar memory.

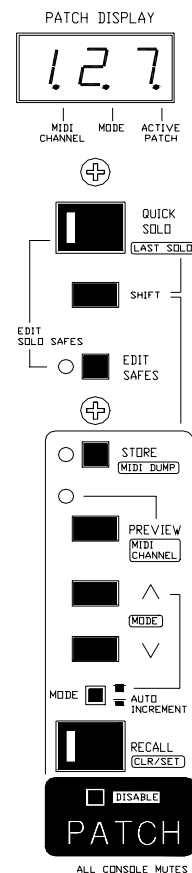

THE MUTE SWITCH



Press **MUTE** once to mute the channel signal.

The red LED will turn on.

The audio signal will turn off (channel muted).

Mute affects the post-fade signal and will also affect the pre-fade signal if the internal option links are configured to do so (factory default setting).

Press **MUTE** again to turn the mute off.

TURN ALL CONSOLE MUTES OFF OR ON

It is often useful to turn off (clear) all the console mutes or to turn them on (set). You may wish to clear the console before starting a new scene or setting up a new group or patch. Alternatively you could set all mutes on and work with just the active channels. Once cleared or set in this way you can overwrite and edit selected groups and patches, or all 128 patches using the 'ALL' function as a starting point for a new show.

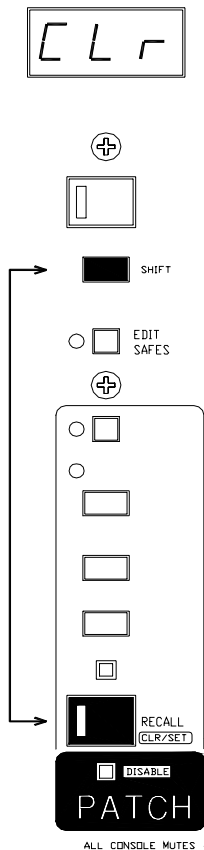

TURN ALL CONSOLE MUTES OFF

Press **SHIFT + RECALL**

The red LED will start flashing.

The display flashes **CLr**

Press any other key to cancel or

Press **RECALL** to confirm.

The LED will turn off.

All console mutes will turn off.

TURN ALL CONSOLE MUTES ON

Press **SHIFT + RECALL**

The red LED will start flashing.

The display flashes **CLr**

Press **SHIFT + RECALL** again.

The display flashes **SEt**

Press any other key to cancel or

Press **RECALL** to confirm.

The LED will turn off.

All console mutes will turn on.

MUTE GROUPS

A mute group lets you mute a selected combination of channels with a single key press. Applications include muting unused channels when mixing different bands, muting all channels except 2-track playback during intermission, muting all effects, muting a bank of radio mics during an instrumental number, muting stage mics during scene changes, and so on...

The **GL4000** includes 8 mute groups controlled by a bank of large buttons to the right of the master faders. These may be selected one at a time or together depending on the mode of operation preferred. Groups may be easily programmed and edited off-line by the user without affecting the console mutes, essential when making changes during a live show. A preview function lets you quickly view the settings of individual groups. Selected channels may be made 'safe' so that they are not affected by the mute groups, necessary when channel assignments are changed during a show. Group settings can be archived via MIDI. If preferred, the system may be disabled when mute groups are not needed so preventing accidental operation.

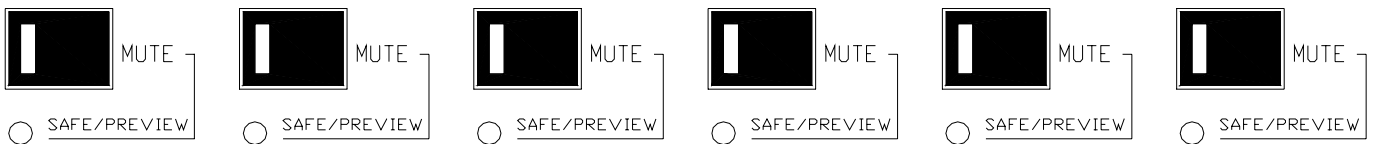

Before starting, decide how you want to use your mute groups. Choose the operating mode for single or multiple groups. Refer also to the section on **MUTE SAFES** for details on how to prevent selected channels from being operated by the groups.

SELECT THE OPERATING MODE

 Set the underpanel **MODE** switch up or down :

Up = **SINGLE**

Recall only one group at a time. The switches are interlocked - pressing another switch cancels the operation of the previous. Typically this is used when the groups recall mute settings for different bands or scenes.

Down = **MULTI**

Recall more than one group at a time. Typically this is used when the groups mute combinations of instruments, mics or effects.

TO DISABLE THE MUTE GROUPS

 Set the underpanel **DISABLE** switch :

Up = Mute groups available

Down = Mute groups turned off

PROGRAM A MUTE GROUP

Press **EDIT GROUP**

The red LED will start flashing.
This puts the mute system into 'edit mode'.
The mute groups are programmed or edited 'off-line'.
This lets you change groups during a live show without affecting the mute status of the channels.

Press the **MUTE GROUP** to be programmed.

The mute group LED will start flashing.
The green **SAFE/PREVIEW** LEDs below the **MUTE** switches will indicate which channels are part of the group.

Press the channel **MUTE** switches.

In edit mode the channel mute switches are used to program the groups. They will not operate the channel mutes until you exit edit mode. However, mute status is always indicated on the channel red mute LEDs.

To edit another group press another **MUTE GROUP** switch.

The settings of the original group will be stored.
The new group LED will start flashing.
Select channel mutes for this group.

Press **EDIT GROUP** again to exit edit mode.

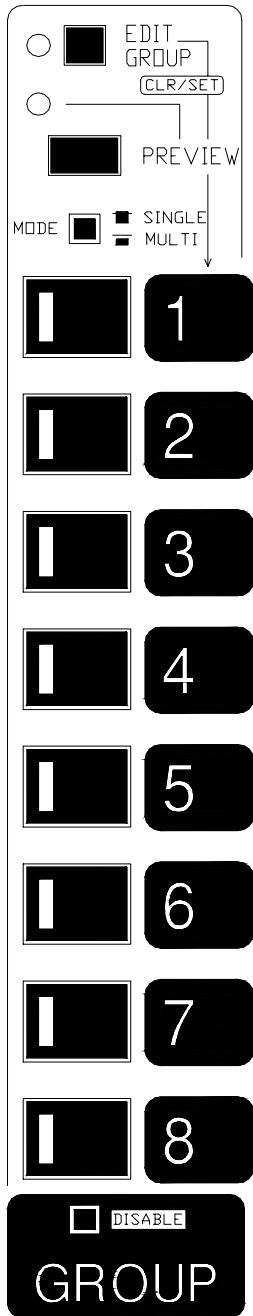

PREVIEW A MUTE GROUP

Press **PREVIEW**

The green LED will start flashing.

Press the **MUTE GROUP** to be previewed.

The mute group LED will start flashing.
The green **SAFE/PREVIEW** LEDs below the **MUTE** switches will indicate which channels are part of the group.

In preview mode no changes can be made to the groups, and the channels can be muted in the normal way.

To preview another group press another **MUTE GROUP** switch.

Press **PREVIEW** again to exit preview mode.

RECALL A MUTE GROUP

Press a **MUTE GROUP** (1 to 8) to turn the group on.

The red LED indicates that the group is selected.
The channels programmed into the group are muted.

Press **MUTE GROUP** again to turn the group off.

TURN ALL MUTES OFF OR ON IN A GROUP

It is often useful to turn off (clear) or turn on (set) all the console mutes within a mute group. This is done in 'edit mode' so that the console mutes are not affected while the group is being edited.

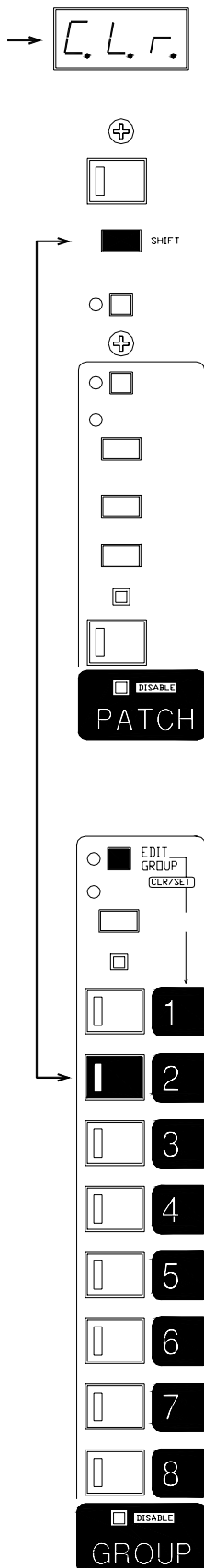

TURN OFF OR ON ALL MUTES IN A GROUP

Press **EDIT GROUP**

The red LED will start flashing.
This puts the mute system into 'edit mode'.

Press the **MUTE GROUP** to be edited.

The mute group LED will start flashing.
The green **SAFE/PREVIEW** LEDs below the **MUTE** switches will indicate which channels are part of the group.

Press **SHIFT + MUTE GROUP**

The display flashes **CLr** (to clear all)

Include the following step to turn all mutes on :

Press **SHIFT + RECALL** again.

The display flashes **SEt** (to set all)

Press any other key to cancel or

Press **MUTE GROUP**

All green LEDs turn off.
The mutes are cleared (or set) in the group.

To edit another mute group press **MUTE GROUP** or

Press **EDIT GROUP** again to exit 'edit mode'.

MUTE SAFES

Mute groups, patches and MIDI overwrite the console mutes with the settings held in memory or an external controller. You may want to prevent selected channels being overwritten, for example if you need to repatch mic channels to deal with a cable break during a live show. In this situation it would not be convenient to reprogram the mute groups and patches. Instead you would operate these channel mutes manually until the show ends. You may also prefer to take manual control of lead performers to prevent their channels being accidentally affected by the mute automation or MIDI.

The **GL4000** includes a 'mute safes' facility so that selected channels can be 'made safe' from the mute groups, patches and MIDI control. These settings are programmed into non-volatile memory so that its contents are retained when power is removed. Channel safes are selected and edited 'off-line' in much the same way as editing the groups. All input channels, groups, aux sends, L, R and M can be made safe. Note that the mute safes do not affect QuickSolo which has its own safes facility described later. The safes setting can be archived via MIDI.

- For channels made 'safe' :
- ✓ Manual muting
 - ✗ Mute groups
 - ✗ Mute patches
 - ✗ MIDI input
 - ✓ MIDI output

THE CHANNEL SAFE/PREVIEW LED



In normal console mode the green LEDs below the **MUTE** switches indicate which channels have been made 'safe'.

In 'edit group', 'preview group' or 'preview patch' mode they indicate channels which have been assigned to a mute group or patch. In 'solo mode' they indicate channels which have been made 'safe' from the solo system.

MAKE A CHANNEL MUTE 'SAFE'



Press **EDIT SAFES**

The red LED will start flashing.

This puts the mute system into 'edit safes' mode.

The channel safes are selected or edited 'off-line' using the **MUTE** switches. This lets you assign safes during a live show without affecting the mute status of the channels.

Press the **MUTE** to be made 'safe'.



The green **SAFE/PREVIEW** LED below the **MUTE** switch will turn on or off to show if the channel will be 'safe' or not.

Press **EDIT SAFES** again to exit edit mode.

MUTE PATCHES

A mute patch lets you store the console mute on/off settings to be recalled with a single key press. This is much like taking a 'snapshot' of the console settings. Mute patches are used extensively for scene or song changes during live performance. The advantage is quick access to complex changes, a growing requirement with the more sophisticated sound control specified today. Patch changes can be linked to external sequencers and effects devices via MIDI for sophisticated show control. Patches can be archived and recalled via MIDI.

The **GL4000** includes 128 mute patch memories. The patch number is simply dialled up on the 3 segment display and its contents recalled or overwritten with the current console settings. Recalling a patch does not overwrite any active groups. Patch settings may be checked before recall by using the preview function. Selected channels may be made 'safe' so that they are not affected by patch changes. If preferred, the system may be disabled when mute patches are not needed.



Before starting, decide how you want to use the mute patch system. Choose the recall operating mode with or without auto increment. If you do not want to use the patch system you can turn it off to prevent accidental operation. Refer also to the section on **MUTE SAFES** for details on how to prevent selected channels from being operated by the patches.

SELECT THE RECALL MODE

 Set the underpanel **MODE** switch up or down :

Up = **MANUAL INCREMENT**

Scroll **▲** or **▼** to select the required patch

Press **RECALL** to recall the patch shown in the display

Down = **AUTO INCREMENT**

The display automatically increments to the next patch number each time **RECALL** is pressed. This lets you step through your patches without having to press **▲** each time.

TO DISABLE THE MUTE PATCHES

 Set the underpanel **DISABLE** switch :

Up = Mute patches available

Down = Mute patches are turned off

THE PATCH DISPLAY

NORMAL MODE

127

Shows selected patch number to or

Indicates which patch which will overwrite the console mutes when you press **RECALL**, or be overwritten when you press **STORE**. The **ACTIVE PATCH** dot tells you how the displayed number relates to the current console mute settings:

ACTIVE PATCH on :

Displayed patch is the last patch recalled.
Console mutes are the same as the displayed patch (except for channels made 'safe').

ACTIVE PATCH off :

Displayed patch is the last patch recalled.
Console mutes have changed since the patch was recalled.

ACTIVE PATCH flashing :

Displayed patch is not the same as the last patch recalled.
This is always the case in 'auto-increment' mode where the display automatically steps up ready for recall.

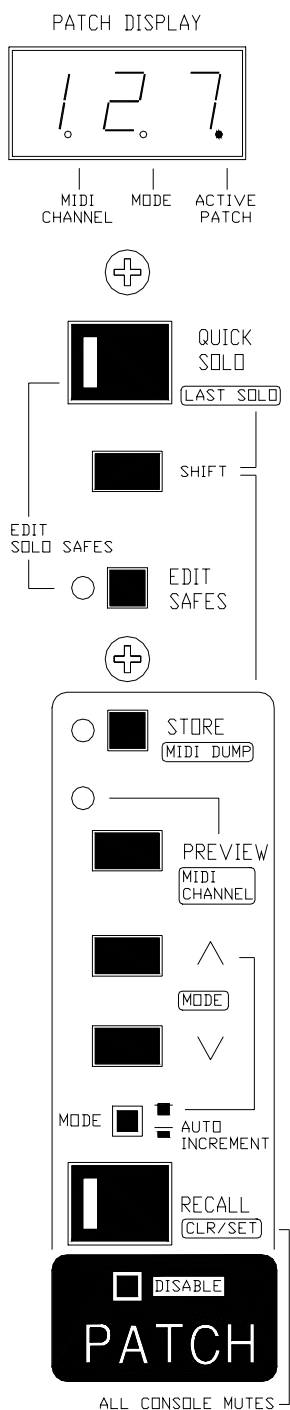

CLEAR OR SET ALL MUTES

CLR SET

Flashes or to warn that all console mutes will be turned on or off when this function is selected.

CONSOLE MODE

5 a =

The **MODE** dot turns on.
2 digit code indicates the selected console mode. Digit 3 shows if the mode is selected (=) or not ().

MIDI CHANNEL NUMBER

.16

The **MIDI CHANNEL** dot turns on.
The display indicates the console MIDI channel number selected. This can be channel to or

SOFTWARE VERSION NUMBER

123

Refer to the section on TECHNICAL SUPPORT.

ERROR CODES

Er2 Ec1

Displays the error number and code referenced in the section on TECHNICAL SUPPORT.

SCROLL THROUGH THE PATCH NUMBERS

The 128 patches are numbered **0** to **127**. Before **0** there is a special patch called **ALL**. This is described later.

Press **▲** or **▼** to increment or decrement to the required patch number.

Hold down **▲** or **▼** for fast scrolling to the required number.

The **ACTIVE PATCH** dot will indicate the status of the current console mutes against the selected patch number. See the section on PATCH DISPLAY.

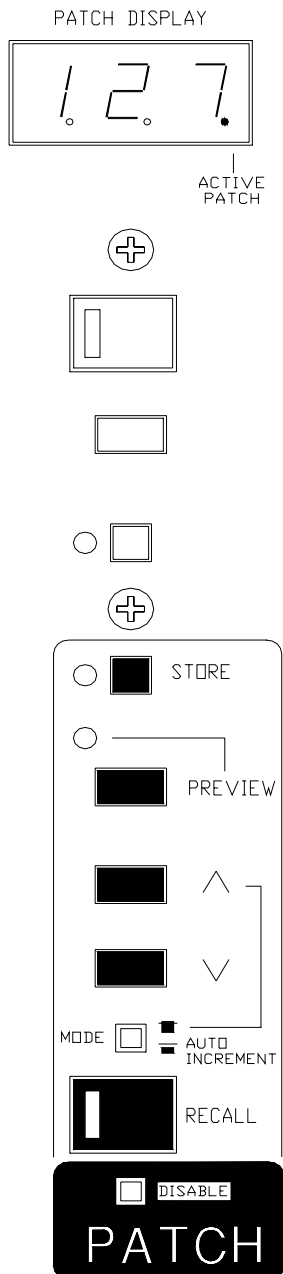

STORE A MUTE PATCH

Operate the mutes to set up the console as required.

Scroll **▲** or **▼** to select the required patch

Press **STORE**

The patch is overwritten with the console setting.

PREVIEW A MUTE PATCH

Press **PREVIEW**

The green LED will start flashing.

Scroll **▲** or **▼** to select the required patch

The green **SAFE/PREVIEW** LEDs below the **MUTE** switches will indicate which channels are muted in the patch.

In preview mode no changes are made to the current mute settings, and the channels can be muted in the normal way.

To preview another patch simply scroll **▲** or **▼**

Press **PREVIEW** again to exit preview mode.

RECALL A MUTE PATCH

Scroll **▲** or **▼** to select the required patch

Press **RECALL**

The console mutes are overwritten with the contents of the selected patch.

Channels made 'safe' are not affected.

Active mute groups are not affected.

THE ALL PATCH

Between patch **127** and **0** is a special patch function called **ALL**. This lets you overwrite all 128 patches with the current console mute settings. You would normally do this before programming the patches for a particular show. Typical use would be :

Turn all mutes off in all patches (clear), then edit the mutes on for required channels.

Turn all mutes on in all patches (set), then edit the mutes off for required channels.

Turn unused channel mutes on before editing the used channels.

Turn mostly muted channel mutes on before editing the patches where they are not muted.



Note that the ALL function overwrites all 128 patches and should be used with care. A confirm function is included to prevent accidental operation.

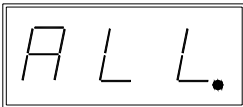

OVERWRITE ALL 128 PATCHES

Operate the mutes to set up the console as required. You may wish to start by clearing or setting all mutes as described previously.

Scroll **▲** or **▼** until the display shows **ALL**

Press **STORE**

The red LED and the display both flash to warn that all patches will be overwritten.

Press any other key to cancel or

Press **STORE** again to confirm the overwrite function.

The display scrolls automatically through all 128 patch numbers as the patch memory is overwritten.

QUICKSOLO

QuickSolo is a system for checking individual signals or combinations of signals in the mix. This is done by muting all channels except for the channel/s being soloed. It is also known as '**solo-in-place**' because the position and relative levels of the signal to all the outputs is retained. QuickSolo affects the main outputs. This should not be confused with the PFL/AFL monitoring system which affects only the monitor outputs. QuickSolo is most useful during sound checking where you can listen to the contribution of individual signals to the mix.

The **GL4000** QuickSolo system lets you quickly solo selected channels using a two key press that prevents accidental operation during a live performance. You can toggle between your last selected solo setting and the full mix to compare the effect. You can make selected channels 'solo safe' to prevent them being muted when QuickSolo is activated. Typically you would solo safe the main outputs and the effects returns so that the soloed channels are heard with effects. Safe channels can be previewed and edited before operating QuickSolo. If not needed QuickSolo can be disabled.



USING QUICKSOLO

Press and hold **QUICKSOLO**

The LED flashes to warn that the solo system is armed ready for you to select a channel mute.

While holding **QUICKSOLO** press the mute of the channel you want to solo.

All console mutes turn on except the selected channel and any made 'solo safe'.

You can turn on or off other mutes while in solo mode to hear the effect of combinations of channels.

Release **QUICKSOLO**

This returns the console to normal mute operation. The previous mute settings are restored.

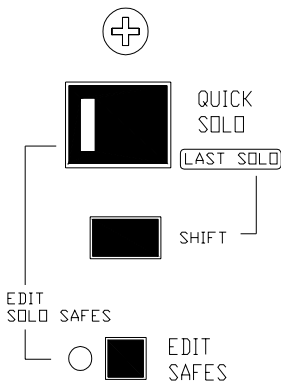

LAST SOLO

Having set up a solo combination you may wish to compare the effect of this with the complete mix. Instead of having to repeat the selection of the channels as above you can recall your last solo combination. You can toggle repeatedly between this and the mix to judge the effect.

Press **SHIFT + QUICKSOLO**

The last solo combination is activated.

While holding **SHIFT** press and release **QUICKSOLO**

This toggles between the last solo and the mix.

Release **SHIFT** or **QUICKSOLO** to restore normal operation.

SOLO SAFES

QuickSolo can mute all the console mutes including channels, aux sends, groups and main outputs. To hear the effect of soloed channels the required outputs should not be muted. You may also wish to always hear the effect of signal processing devices such as reverbs connected to the console aux sends and returns. Here, the aux sends and channels allocated as effects returns should not mute when solo is activated.

The **GL4000** includes a 'solo safe' facility so that selected mutes can be disabled from the solo system. This works in the same way as the 'mute safes' described earlier but affects solo and not the mute groups or patches. Any mutes made 'safe' can be previewed and edited before QuickSolo is activated and without affecting the console mute status. Solo safe settings are retained on power off and can be archived via MIDI.

MAKE A CHANNEL 'SOLO SAFE'

Press and hold **QUICKSOLO**

The LED flashes and the console is armed ready for solo operation. No mutes are affected.

The green **SAFE/PREVIEW** LEDs show which channels are already 'solo safe'.

While holding **QUICKSOLO** press **EDIT SAFES**

Both the **QUICKSOLO** and **EDIT SAFES** LEDs flash to show that the console is in 'edit safes' mode.

While holding both, press a channel **MUTE** switch.

The **SAFE/PREVIEW** LED toggles on or off to show if the channel will be made safe.

Select all the mutes you wish to make safe.

The **SAFE/PREVIEW** LEDs will show these every time you arm or operate QuickSolo.

Release **EDIT SAFES** to exit 'solo safe' mode ready to activate QuickSolo, or

Release **EDIT SAFES** and **QUICKSOLO** to return the console to normal operation.

TO DISABLE OR ENABLE QUICKSOLO

Enter **CONSOLE MODE** by pressing **SHIFT + ^** together.

The display indicates **So=** (solo on)

While holding **SHIFT + ^** press **RECALL**

Leave the display set for solo mode on or off :

So= (solo on) or **So** (solo off)

If you try to use QuickSolo while disabled the display will indicate **OFF** and none of the console mutes will be affected.

MIDI

The Musical Instrument Digital Interface (MIDI) was originally conceived to standardise the interconnection between keyboards and other instruments. It is now found on all manner of equipment including sound and lighting consoles, effects devices and computers. Sophisticated recording and live sound control is now possible by interfacing sound consoles with other MIDI equipment.

The **GL4000** includes a full opto-isolated Musical Instrument Digital Interface(MIDI) system. Standard 5-pin **IN**, **OUT**, **THRU** sockets allow connection to external MIDI equipment including computer show control systems, sequencers, data archiving systems, musical instruments and so on. The console mute system can control or be controlled using MIDI. Applications include sophisticated 'hands-off' mute scene control, effects and instrument patch control, simultaneous control of several consoles and archiving of the mute settings for later recall.

Pressing console mutes transmits MIDI Note On messages. Recalling patches transmits MIDI Program Change messages. Similarly receiving the MIDI Note On and Program change messages overwrites the console mutes and patches. The console mute memory can be dumped out or in using MIDI System Exclusive messages. The console can be set to operate on any MIDI channel. If required MIDI can be disabled.

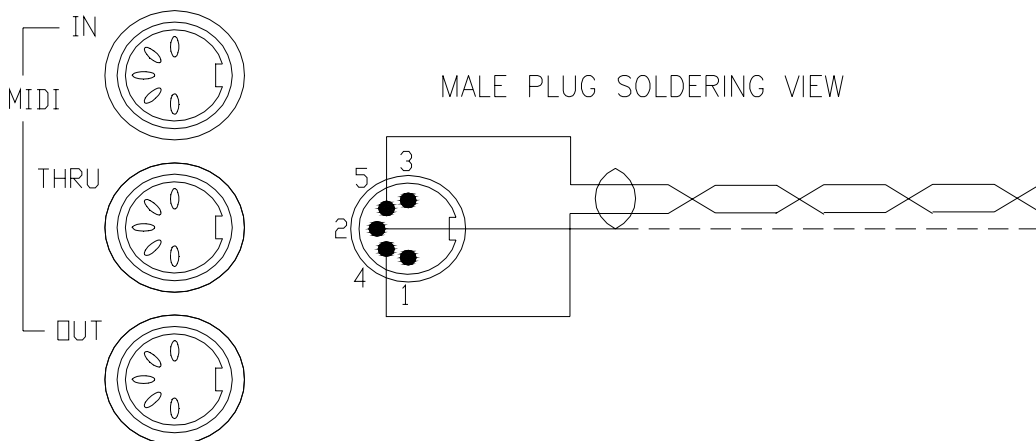

THE MIDI CABLES

Use standard 5-pin 180' male-to-male MIDI cables which are available from your local audio dealer or music shop. These should not exceed 15 meters (50 feet) in length. To control external equipment plug MIDI **OUT** to MIDI **IN** on the connected equipment. To control the console plug external MIDI **OUT** or **THRU** to console MIDI **IN**. To pass MIDI through the console to the external equipment plug console MIDI **THRU** to MIDI **IN** on connected equipment.

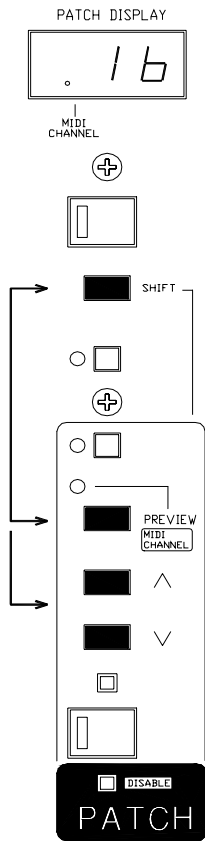

SELECT THE CONSOLE MIDI CHANNEL

Press and hold **SHIFT + PREVIEW PATCH** together to enter 'MIDI mode'.

The display MIDI dot turns on and the current MIDI channel number is shown.

While holding **SHIFT + PREVIEW** scroll through the MIDI channel numbers using **^** or **v**

Leave the display set to the required MIDI channel number **.1** to **.16**

Release **SHIFT + PREVIEW** to exit.

DISABLE THE CONSOLE MIDI SYSTEM

Enter 'MIDI mode' as above.

While holding **SHIFT + PREVIEW** scroll through the MIDI channel numbers using **^** or **v**

Leave the display set to **OFF**

Release **SHIFT + PREVIEW** to exit.

CHANNEL MUTES

Pressing any console mute switch transmits a MIDI Note On message unless MIDI has been disabled. Similarly receiving the correct Note On message will control the channel mute unless it has been made 'mute safe' or MIDI disabled.

Console mutes are mapped to MIDI Note numbers as shown. Running status is supported on receive and transmit.

TRANSMIT - Pressing a console mute transmits the following Note On message:

9n cc vv cc 00

where n = console MIDI channel number
 cc = console channel number
 vv = 3FH for mute off, 7FH for mute on

RECEIVE - The console responds to the following MIDI Note On message :

9n cc vv (00 is ignored)

MUTE PATCHES

Recalling a patch will transmit a MIDI Program Change message unless the patch system is disabled or MIDI is disabled. Similarly receiving the correct Program Change message will recall a console patch unless disabled.

Console patches are directly mapped to MIDI Program Change numbers 0 to 127. Running status is supported on receive and transmit.

TRANSMIT and RECEIVE - The message format is :

Cn pp

where n = console MIDI channel number
 pp = console patch number 0-127

MIDI DUMP FORMAT

The format for Dump In and Dump Out is identical. The Dump is made up of 128 System Exclusive messages (or packets) which contain the contents of the console memory.

TRANSMIT and RECEIVE - The format for a single packet is as follows :

F0 <sysex header> <packet no.> <data> <checksum> F7

<sysex header> = 00 00 1A 50 05 VV vv nn

VV = major software version number V1.23

vv = minor software version number V1.23

nn = console MIDI channel number

<packet no.> = packet number from 0 to 127

<data> = 7 bit block of console data followed by a number of 00 pad bytes.

<checksum> = checksum to allow error detection.

HEX		CONSOLE	
5E	47	[REDACTED]	48 5F
5C	45	[REDACTED]	46 5D
5A	43	[REDACTED]	44 5B
		[REDACTED]	42 59
		[REDACTED]	41 58
57	40	[REDACTED]	39 56
55	38	[REDACTED] C5	37 54
		[REDACTED]	36 53
52	35	[REDACTED]	34 51
50	33	[REDACTED]	32 4F
4E	31	[REDACTED]	30 4D
		[REDACTED]	29 4C
4B	28	[REDACTED]	27 4A
49	26	[REDACTED] C4	25 48
		[REDACTED]	24 47
46	23	[REDACTED]	22 45
44	21	[REDACTED]	20 43
42	19	[REDACTED]	18 41
		[REDACTED]	17 40
3F	16	[REDACTED]	15 3E
3D	14	[REDACTED] C3	13 3C
		[REDACTED]	12 3B
3A	11	[REDACTED]	10 39
38	9	[REDACTED]	8 37
36	7	[REDACTED]	6 35
		[REDACTED]	5 34
33	4	[REDACTED]	3 32
31	2	[REDACTED] C2	1 30
		[REDACTED]	G8 2F
2E	G7	[REDACTED]	G6 2D
2C	G5	[REDACTED]	G4 2B
2A	G3	[REDACTED]	G2 29
		[REDACTED]	G1 28
27	A8	[REDACTED]	A7 26
25	A6	[REDACTED] C1	A5 24
		[REDACTED]	A4 23
22	A3	[REDACTED]	A2 21
20	A1	[REDACTED]	
		[REDACTED]	
		[REDACTED]	
1B	A9	[REDACTED]	A10 1C
19	R	[REDACTED] C0	M 1A
		[REDACTED]	L 18

MIDI DUMP DATA

When a MIDI **DUMP OUT** is performed the entire contents of the console memory is transmitted down the selected MIDI channel. This includes the current console mute settings, mute groups, patches, safe settings, solo settings, console modes, and console MIDI channel number. When a MIDI **DUMP IN** is received the console memory is completely overwritten.

This is ideal when you want to archive settings and recall them at a later date, for example a re-run of a previous performance. You can also use the dump facility to program additional **GL4000** consoles, for example when setting up duplicate shows or swapping consoles around.

MIDI Dump Out

Press **SHIFT + STORE**

The dump is started down the selected console MIDI channel. If MIDI has been disabled (channel = OFF) then nothing will happen when dump is activated.

The display flashes **dPo** during the duration of the dump (around 15 seconds).

While dump is in progress the mute group and patch system is locked out. However, the channel mutes may be operated in the normal way so that live operation may continue unaffected.

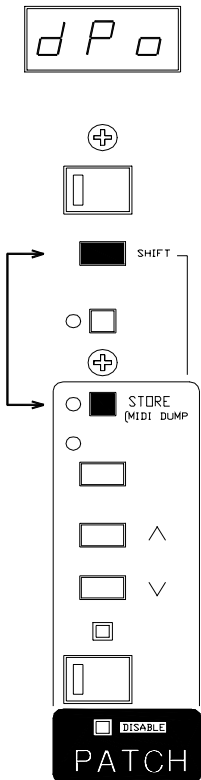

MIDI Dump In

The console responds automatically to the System Exclusive dump in message formatted as above.

While the console is receiving dump in data the display flashes **dPI** (around 15 seconds).

While dump is in progress the mute group and patch system is locked out. However, the channel mutes may be operated in the normal way so that live operation may continue unaffected.

On completion the console restores normal operation with the new memory settings in place.

DUMP ERRORS

If the console or connected equipment fails to respond to a MIDI dump then check that the MIDI is correctly enabled on each. Check that the cables are correctly plugged. In the event of a data error being detected during a MIDI dump out or in the display will show an error message code. Refer to the section on TECHNICAL SUPPORT for an explanation of these.

TECHNICAL SUPPORT

Should you have any queries about the **GL4000** console automation system please quote the console model, serial number and software version number in any communication with Allen & Heath or appointed service agent. The system has been designed and tested to be reliable under the harsh conditions typical of live sound 'on the road'. Should a problem be encountered check first that external equipment is correctly connected and functional (or disconnected to test the console itself), that the equipment has been correctly set up, and that the mains power is correct for the console power unit. Error detection systems have been built in to assist with problem investigation.

POWER UP AND POWER DOWN

The console settings are remembered when power is removed from the console. A power down circuit detects falling voltage and writes the settings to non-volatile memory. On power up these settings are restored. Mains power fluctuations ('brown-outs') are detected with error code readout.

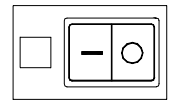

CONSOLE DC POWER INDICATORS

The console power unit converts mains voltage to the DC supply rails required by the console. Each rail has an associated indicator LED on the front panel. If a power rail fault is suspected check that these LEDs are correctly illuminated. Note that the optional **RPSD2** dual power supply monitor includes further power supply status monitoring.

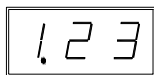
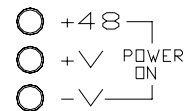

SOFTWARE VERSION NUMBER

Press **SHIFT + PREVIEW GROUP**

The software version number is shown on the patch display. For example, **1.23** is version V1.23

Release the keys to return to normal display.

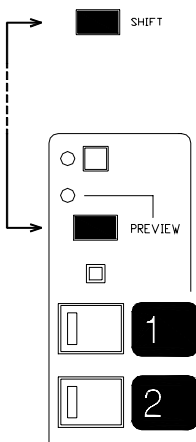

SOFT RESET

Should the system lock up and fail to clear itself first press the underpanel **RESET** button above the rear panel MIDI sockets. This restarts the processor as if the console was powered off and then on, except that the console may not reset to the last active mute settings.

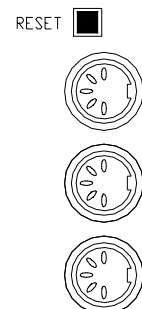

HARD RESET

Should the console memory become corrupted it can be reset to the factory defaults by performing a hard reset :

Hold down **EDIT GROUP + PREVIEW GROUP** while powering up the console. The following condition set :

All console mutes turned on.

Patch display shows **0**

All mute patches cleared (mutes turned off).

All mute groups cleared (mutes turned off).

MIDI channel set to 16.

No mute safes set.

No solo safes set.

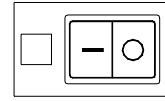
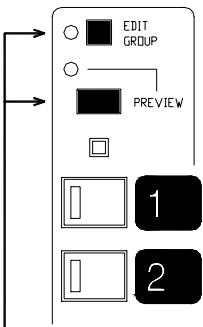

ERROR MESSAGES

In the event of an automation error an error message is displayed. This is a two part message comprising an error number and an error code. For example, should a MIDI Dump In error be detected the following **error number** will be displayed :

En0

Press any automation key to show the **error code** which gives further information about the error.

Ec1

Press any automation key to clear the error display and return the system to normal operation.

The following **ERROR MESSAGES** apply :

NUMBER	CODE	DESCRIPTION
0		MIDI Dump In error
	0	Packet 0 not received
	1	Missing packet
	2	Buffer overflow
	3	Checksum error
	4	Dump timeout
1		EEPROM memory access error
	0	Write error
	1	Page write error
	2	Read error
	3	Page read error
	4	Byte read error
2		Power brown-out detected

Er 1

Ec 0

FRONT-OF-HOUSE WITH RECORDING

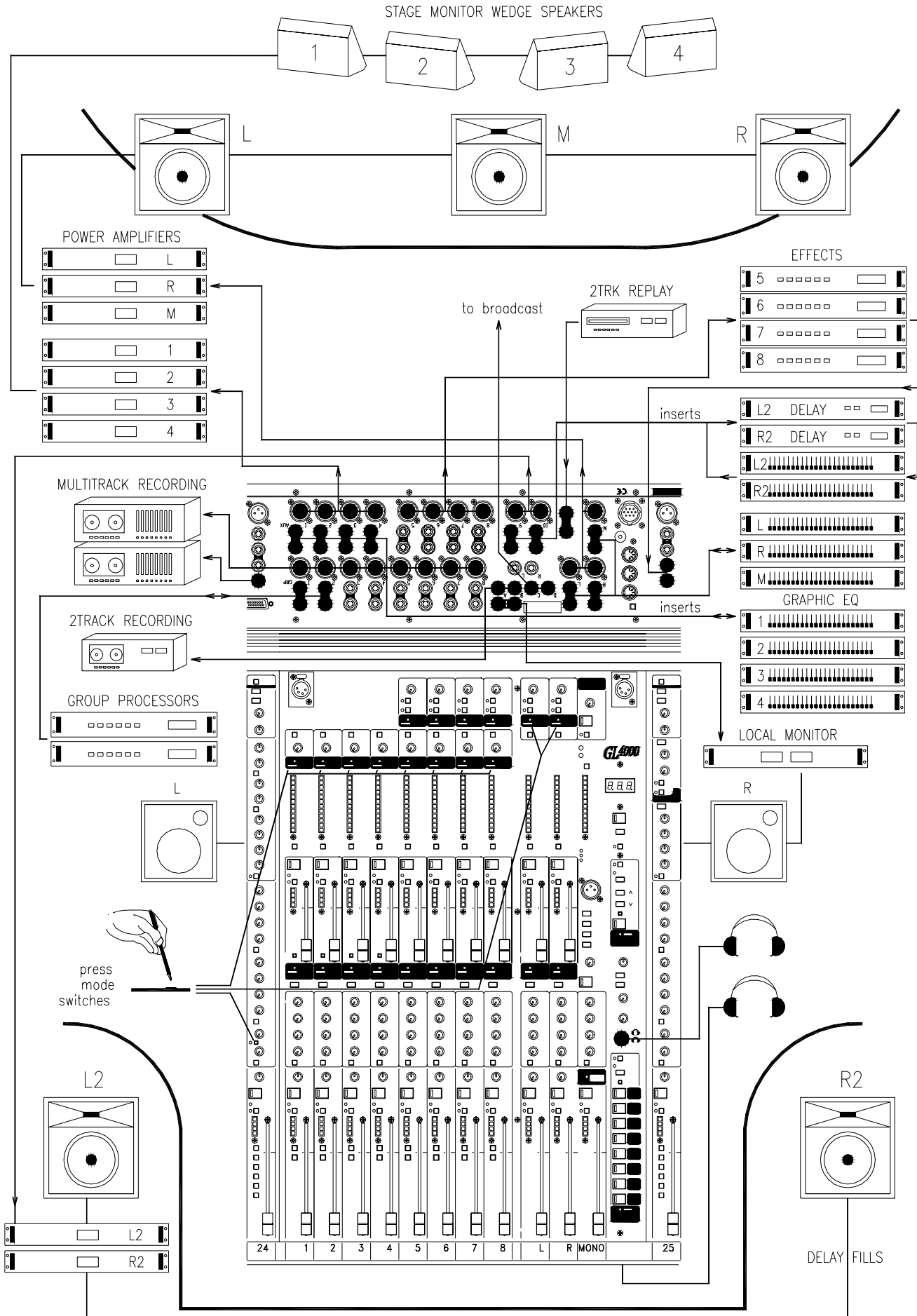

USING THE **GL4000** FOR FRONT-OF-HOUSE (FOH)

The console is positioned within the listening area so that the sound fed to the audience can be accurately balanced and controlled. In larger systems the performers monitors may be controlled from a separate console positioned at the side of the stage (on-stage monitor). Where this is not possible the monitors are controlled from the FOH console. You may also be required to provide separate recording, broadcast and zone feeds, and even record the show for the performers.

This application demonstrates the versatility of the **GL4000**. Here, the console controls a LCR + delay fill speaker system, stage monitors, stereo broadcast feed, with 2-track and multitrack recording. Signal processing devices such as effects and graphic EQ are shown inserted.

THE IMPORTANCE OF INSERTS ON THE OUTPUTS

A graphic equaliser is inserted into each of the main L,R and M outputs to adjust for the natural acoustic resonances which can colour the sound and result in troublesome acoustic feedback. Inserting these rather than plugging them between the console outputs and amplifier inputs gives two advantages:

1. The long cable runs can be driven from the console balanced XLR outputs without signal loss and interference pickup. Many lower cost graphics do not have this drive capability.
2. You can monitor the effect of the graphic using **AFL**.

THE MAIN LEFT, CENTRE, RIGHT (LCR) OUTPUTS



Most sound systems use speaker stacks positioned left and right of the stage. Larger systems and many fixed theatre systems include a mono stack hung centrally above stage front. Here, the main sound source such as vocals is sent to the mono stack while music and effects may be sent to LR. The stereo image is usually kept narrow for the benefit of the audience positioned closer to one of the speaker stacks.

Use group **PAN** to control the stereo image to LR.

Use **LR to MONO** to mix some LR to the mono output to get the best balance between the speakers.

THE LR DELAY FILLS

In larger venues additional 'fill' speakers are positioned nearer to the audience seated furthest from the stage. In a theatre these may feed the raised balcony. The intention is to improve clarity without distracting the audience from the source of the sound itself. Because of the distances involved the acoustic delay between the originating sound source and the fill speakers becomes obvious to the listener as a distracting delay (around 1millisecond per foot). It is also important to EQ the sound to prevent distraction, usually by removing some LF and HF. In some cases you may wish to send a different mix from LR to the fill speakers. The **GL4000** offers two ways of controlling fills :

1. Use the **MATRIX** outputs if you want the fill mix to be different to the LR mix. Select  **OUT REV** for balanced XLR output and inserts, or
2. Use the **LR2** outputs with **POST** selected so that the fills follow the LR faders. Here, the balance between the main speakers and fills is set using the LR2 output level trims. Select  **OUT REV** for XLR and inserts. Patch a stereo delay unit and graphic EQ into the inserts. Adjust these to remove the audible delay at the listening position, and to EQ for least distracting effect. Use **AFL** to check the effect of the inserted equipment.

THE MONITORS

Otherwise known as foldback or cue sends, the monitor mixes are created from the console aux sends. These feed amplifier/speaker systems positioned on-stage for the performers, backstage for the stage crew, in the pit for the orchestra, and so on.

The channel aux sends are usually set **PRE** (pre-fade) for monitors so that they are independent of the front-of-house mix levels. However, you may choose to set certain channels **POST** such as radio mics to prevent 'dressing room talk' or background noise getting to the monitors.

The aux outputs are balanced XLR to drive the long cable runs to the amplifiers. Use the inserts to patch in the graphic EQ or other signal processing devices required. You should 'ring out' the monitors and set the EQ to minimise the effect of acoustic feedback. The effect on the signal can be checked using **AFL**.

EFFECTS

This example shows auxes 5 to 8 sending console signals to external effects units such as reverbs and multi-effects processors. The sends are set **POST** so that signal sent to the effects unit always follows the fader level. The processed signal is returned to the mix via an input channel, usually a stereo channel.

If you are using the stereo channels for additional mic inputs you can still route the return signal to the stereo line input and press **DIR to LR**.

Use **WIDTH** to adjust for the required stereo image from reversed stereo, through mono, to normal stereo, and on to 'wide' for enhanced stereo.

Check the incoming 'wet' signal using **STEREO PFL**.

If it is more convenient to use jack outputs instead of XLRs for the effects sends then simply press  **OUT REV** to swap with the related matrix or LR2 output.

For local effects (associated only with one channel) press the channel  **DIR OUT** switch and use aux 10 level to adjust the amount of effect.

INSERTED SIGNAL PROCESSING

Apart from EQ, delay and other processing inserted into the main outputs you can similarly plug external signal processing devices into the input channel and group signal paths. Noise gates can clean up noisy sources such as keyboards when they are not played. Spill from drum mics can be reduced by gating them. Compressors can be useful on vocals to control the dynamic range.

Feed the console signal to the device from the **INSERT SEND** and return the processed signal to the **INSERT RETURN**. Plugging into the return breaks the signal path within the console.

LOCAL MONITORING

2 stereo headphone outputs and a separate stereo 'local monitor' output with its own level control are provided so that the console signals can be checked independent of the main outputs. It is increasingly common during system rigging and sound checking to monitor using speakers positioned at the console.

Select **L-R MIX** to check the stereo LR output. This is interrupted by any pressed **AFL** which in turn is interrupted by **PFL**. This lets you monitor the selected output using **AFL** (for example matrix) and check channel signals quickly by pressing **PFL**.

Turn off **L-R MIX** to keep the monitors quiet unless **AFL** or **PFL** is selected. This prevents unnecessary distraction during a live performance.

Check the mono compatibility of a stereo signal by pressing **MONO**. The L, R and M meters also provide a visual check.

LIVE 2-TRACK RECORDING

A simultaneous stereo recording can be made of the performance by feeding additional console outputs to a 2-track such as a cassette or DAT recorder. The **GL4000** offers several methods depending on the application. In each case a separate output level trim is provided so that you can match the console to the operating level of the recorder, usually +4dBu (high level) or -10dBV (low level). AFL is provided so that the recording level can be checked independent of the live mix :

1. Use the **LR2** outputs. This gives you separate control of the left and right signals to adjust for any imbalance in the mix. Select **POST** if you want the recording to follow the faders. Select **PRE** to record independent of the faders.
2. Use the **MATRIX** outputs if you want the recording mix to be different to the LR mix. This is often the case in live sound where the LR speakers supplement the natural sound generated by acoustic instruments or the 'back line' sound from the musicians own amplifiers. Typically, the LR mix may have plenty of vocals, effects and drum kit but be noticeably lacking in guitar and other instrument groups. Boost the content of these by raising the related group to matrix sends.
3. Use spare **AUX** sends when you are already using the **LR2** and **MATRIX** outputs, such as in a multi-speaker system. The recording mix can be completely different to the live mix (**PRE**), or set up to follow the faders (**POST**).

MONITORING THE 2-TRACK RECORDING

Plug the 2-track recorder outputs into the console **2-TRACK RETURN** sockets. You can check the recording using headphones or the local monitor system by pressing 2-track **STEREO PFL**. The L,R and M meters show the stereo and mono levels of the recording. Press **MONO** to listen to the mono compatibility of the recording.

2-TRACK TO LR REPLAY

You can replay your stereo recording through the LR speaker system by pressing **REPLAY TO LR**. The signal is sent to the outputs pre-insert and pre-fader. The 2-track return may also be used to replay **background music** to the PA during intermission. Set up a mute group to turn off the channels, groups and aux sends during replay. This lets you leave the faders set ready for the next act.

LIVE MULTITRACK RECORDING

It is increasingly common for the performers to commission multitrack recordings of the show for their own purposes. The **GL4000** provides the facility for simultaneous multitrack recording whether operating as a front-of-house or on-stage monitor console. Later, and without the distraction of the live sound, the multitrack can be mixed down to stereo and effects added to produce a more balanced mix.

Record from the **subgroups**. Select  **TRIM ON** to enable the separate group output level control to adjust for the operating level of the multitrack. Select **PRE** if you want to record independent of the group fader which is being used to adjust the subgroup level to LR.

Record from individual **channels**. Select  **DIR OUT** for output level trim of the channel signal to the multitrack. This also lets you select **PRE** or **POST** channel fader depending on your preference.

With these facilities, the **GL4000** is a fully capable multitrack recording console in its own right, offering the live sound engineer the ability to create his own studio quality recordings.

ON-STAGE MONITOR

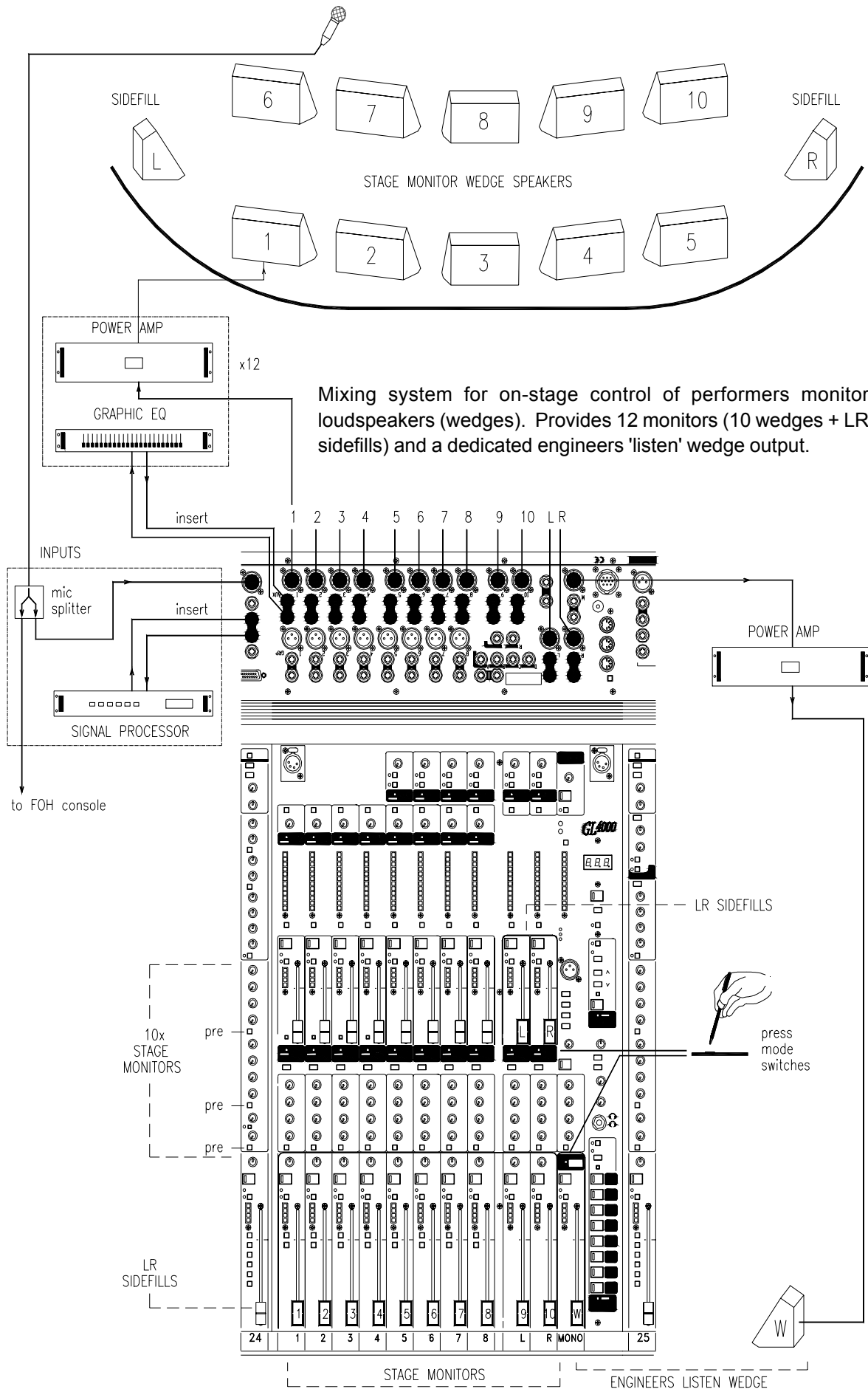

USING THE GL4000 AS A MONITOR CONSOLE

The **GL4000** can be easily configured to function as a dedicated 12 buss on-stage monitor console. Here, the console is positioned at the side of the stage giving the monitor engineer a clear view of the performers on stage. The sound sources are split to feed both the front-of-house console which controls the PA mix, and the monitor console which controls only the mix to the musicians own monitor speakers.

SPLITTING THE SOURCES TO THE CONSOLES

Use on-stage mic splitters or DI boxes to feed each source to both consoles. Decide which console is to provide phantom power.

THE MUSICIANS MONITORS

These are usually wedge shaped speakers positioned in front of and facing each musician or group of musicians. Each mix is created to supplement the sound field heard by the musician. Good visual and audible communication is important to achieve the balance required by each performer. Up to 10 such monitor mixes can be created using the channel aux sends. Graphic EQs are used to minimise acoustic feedback.

Configure monitor mode by pressing  **GRP REV** for aux outputs on the main faders. Set the aux sends **PRE** so that they operate independent of the faders.

Plug a graphic EQ into each aux **INSERT**. Set this up by 'ringing out' the system (tuning out the frequencies most prone to feedback). Use **AFL** to check the processed output.

Set the **STEREO PFL METER** switch up so that the meters 9 and 10 (LR) are not interrupted by PFL. The post-insert, pre-fade signal level can be checked on the buss meters, the output level on the main meters.

Use **TB TO AUX** to talk to each monitor as required.

THE STEREO SIDEFILLS

Use the LR outputs to feed a monitor speaker positioned at each side of the stage. This is used to supplement the sound field heard across the stage and is balanced using the channel faders and pan controls. The output is controlled using the small faders.

THE ENGINEERS LISTEN WEDGE

It is important that the engineer is able to check each monitor exactly the way it is heard by the performers. This is best done by using an identical monitor speaker (wedge) positioned next to and facing the engineer.

Configure the mono output as the listen wedge feed by selecting  **MONO SOURCE** for AFL/PFL.

Check the required monitor mix by pressing **AFL**. Check any channel source by pressing **PFL**. PFL overrides any selected AFL so that you can quickly check a problem source while listening to a monitor output. With no AFL or PFL selected the monitor is quiet.

Set the **PFL TRIM** control to adjust the PFL listen level relative to AFL. It is often the case that monitors are run 'cold' resulting in AFL listening levels a lot quieter than PFL on a correctly set channel.

It is best not to insert a graphic EQ into the engineers monitor output. Listening to a monitor by pressing **AFL** lets you hear the effect of the graphic plugged into that monitor exactly as the musician hears it.

Note that pressing **TALK** automatically dims the listen wedge by 20dB to prevent feedback between the speaker and talkback mic.

STEREO IN-EAR MONITORING

The LR mix can be used to feed a stereo in-ear monitoring system, often preferred by lead performers. A more precisely balanced mix can be created using the channel faders and pan controls. It is usual to plug limiters into the LR inserts to avoid possible hearing damage to the performer. Check the in-ear mix using the stereo headphones or by feeding the local monitor output to a duplicate in-ear system.

USING THE GROUPS AND MONO IN MONITOR MODE

Groups 1 to 8 and L-R are available from their respective XLR outputs and inserts. In monitor mode they are controlled on the small faders as the auxes are reversed on to the main faders. The post-fade outputs can be monitored using **AFL** and checked on the main meters by selecting the meter switches to **SML**. The mono mix M has no dedicated output but has an insert and is accessed through the matrix. The LR outputs are used as previously described to feed the stereo sidefills or in-ear monitor system. However, the 8 groups are available as subgroups to LR, feeds to the matrix, recording sends, effects sends or additional monitor outputs :

SUBGROUPS TO LR - The groups always feed the pan control and LR, M routing switches. By selecting **LR** you can create stereo or mono subgroups to the LR sidefills or in-ear monitor.

FEEDS TO THE MATRIX - The groups, LR and M always feed the matrix send controls pre or post fader as selected. The 4 matrix outputs can be used for recording, effects, additional local monitoring and so on. Note that the **monomix** is available through the matrix.

EFFECTS SENDS - Use the group outputs (XLR) or matrix outputs (jack) for effects sends. These can be returned to the monitors through the stereo input channels.

ADDITIONAL MONITOR OUTPUTS - The groups can feed additional monitors if required. Balanced XLRs drive the amplifiers and you can patch the graphics into the inserts. The group signals follow the channel fader and pan controls and so could be used to set up additional stereo in-ear monitors.

MULTITRACK RECORDING - The groups outputs can be connected to a multitrack to record the show independent of the monitors if required. The output level can be separately adjusted to match the multitrack operating level by selecting  **TRIM ON**.

RECORDING FROM THE MONITOR CONSOLE

The **GL4000** provides the unique facility to record the show from the monitor console rather than additional dedicated recording console. This significantly adds to the value of the service offered to the performers in situations where the front-of-house engineer is overworked or budget and time are tight.

MONO - Record from the mono mix through the matrix.

2-TRACK - Record from the LR mix with full fader and pan control.

MULTITRACK - Record as many tracks as you require from the groups and channel direct outputs, all with level trim.

Monitor the recording using the stereo headphones and local speaker monitor independent of the monitor listen wedge.

MULTI-SPEAKER SYSTEM

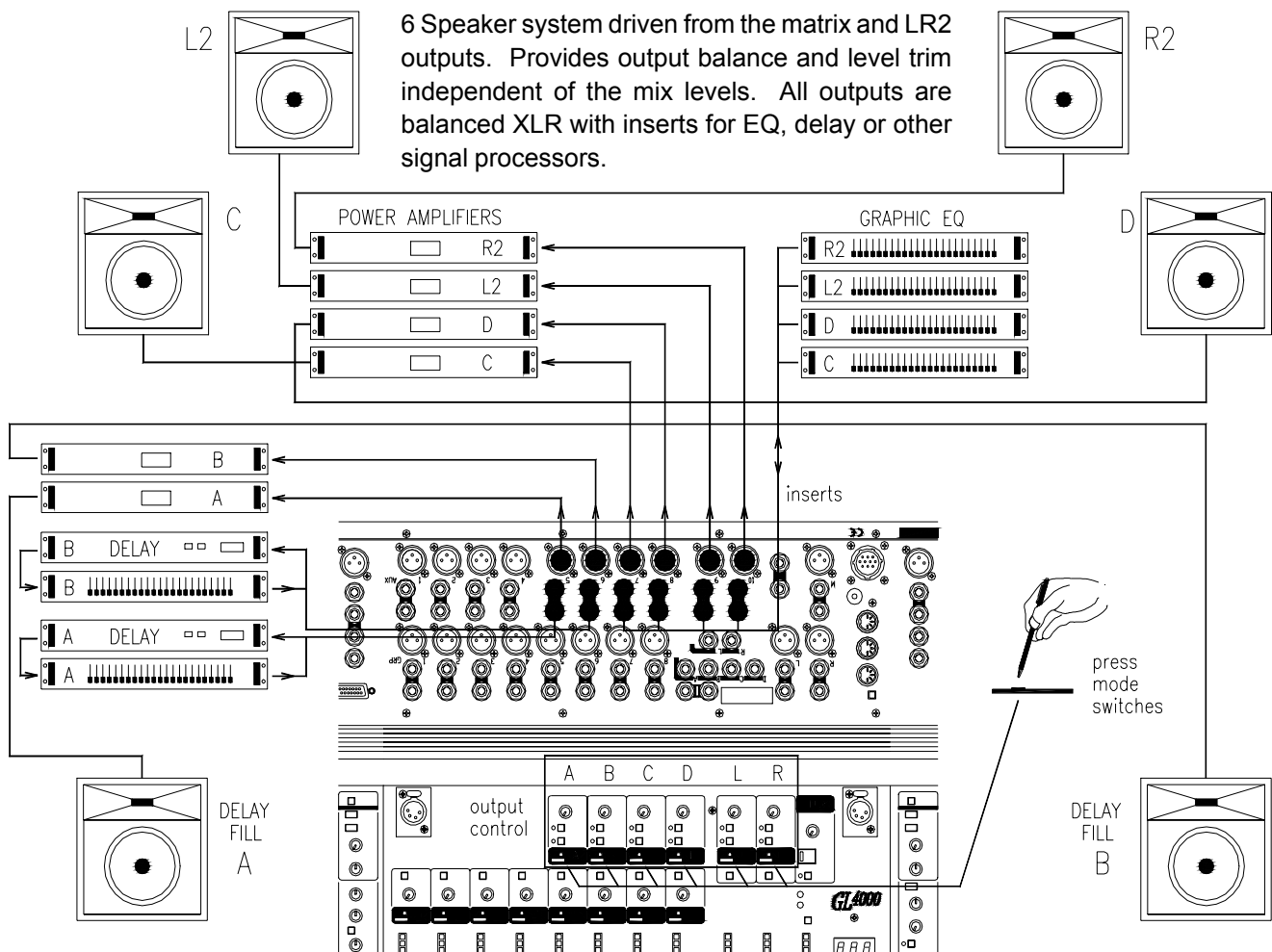

OUTPUT LEVEL MATCHING AND BALANCE

This example shows the matrix and LR2 outputs feeding the speaker system. Here all the output controls are grouped together at the top of the panel away from the normal operating area. Select **POST** for LR2 so that the output follows the LR faders. Adjust **LEV** to match the operating level of each amplifier to give the desired listening level with optimum console signals (faders and meters operating around '0'). A correctly matched system ensures the best signal-to-noise and headroom performance. The balance between the speakers can also be adjusted using **LEV**. Press **ON** to turn on or off selected speakers in the system, useful in checking the effect of each. Use **AFL** to monitor each output post level control but pre ON switch.

OUTPUT DRIVE AND INSERTS

Select **OUT REV** for interference free balanced XLR drive to the amplifiers. This also provides an insert on each output for graphic EQ, delays and other signal processing devices. Inserting graphics lets you tune the frequency response of each speaker in the system for best clarity, acoustic correction and feedback reduction.

THE MATRIX MIX AND DELAY SPEAKERS

Use the matrix to create the required mix to the delay speakers which improves the intelligibility of the sound to the rear of the audience. The balance of the group signals to the matrix may be different to the subgroups feeding LR to ensure that the focus of the sound is not lost. Insert a delay unit to compensate for the acoustic delay from stage to speakers. Insert a graphic EQ to compensate for the local acoustics and to remove some LF and HF which may distract the listener from the true source of the sound.

INTERNAL LINK OPTIONS

The **GL4000** is configured to satisfy most applications that should be encountered. However, the following internal link options are offered for those applications that may require alternative settings. These options require access to the internal circuit assemblies and resoldering of circuit board links. This work should be carried out by technically competent personnel. Further information is available in the separately available service manual and from your Allen & Heath agent.

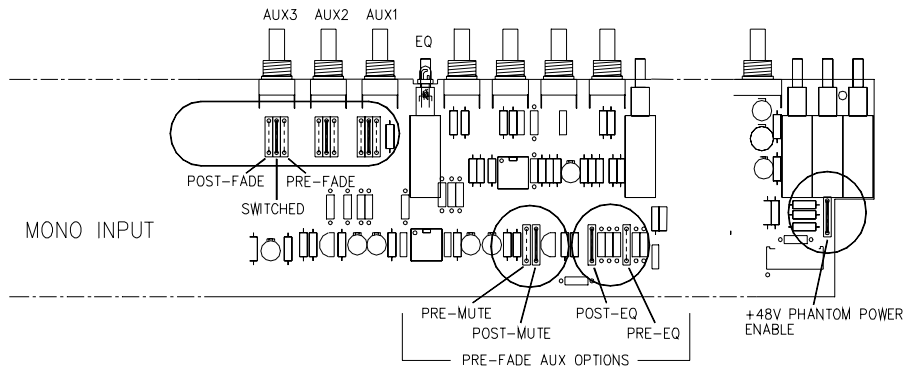

MONO CHANNEL

Set individual aux sends to be permanently pre-fader or post-fader rather than switched. Re-position wire links.

Set the pre-fade aux sends to be pre-EQ rather than post-EQ. Re-position a wire link.

Set the pre-fade aux links to be pre-mute rather than post-mute. Re-position a wire link.

Disable +48V phantom power so that the panel switch has no effect. Cut out the wire link.

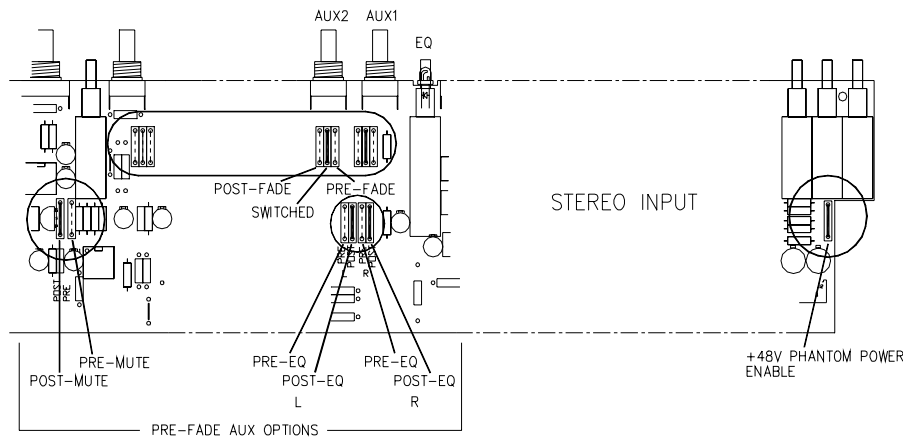

STEREO CHANNEL

Set individual aux sends to be permanently pre-fader or post-fader rather than switched. Re-position wire links.

Set the pre-fade aux sends to be pre-EQ rather than post-EQ. Re-position 2 wire links.

Set the pre-fade aux links to be pre-mute rather than post-mute. Re-position a wire link.

Disable +48V phantom power so that the panel switch has no effect. Cut out the wire link.

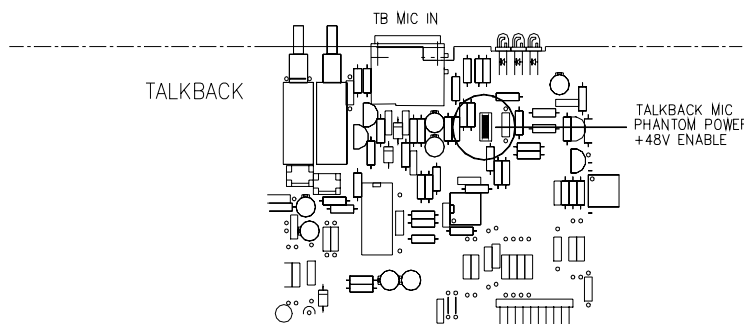

TALKBACK MIC +48V

Disable +48V phantom power from the TB mic input XLR. Remove a jumper link (fit on 1 pin to keep in console).

ALLEN & HEATH GL4000

OPERATING MODES
 FRONT OF-HOUSE
 NORMAL OPERATION
 SET ALL MODE SWITCHES UP
STAGE MONITOR
 PRESS (PREV) (L-REV) (R-REV)
 AUC OUT TO STAGE MONITORS
 PRESS (L-REV) (R-REV)
 PRESS (PREV) (L-REV) (R-REV)
 PRESS (L-REV) (R-REV)
RECORDING LIVE
 PRESS (PREV) (L-REV) (R-REV)
 PRESS (L-REV) (R-REV)
 PRESS (PREV) (L-REV) (R-REV)
 PRESS (L-REV) (R-REV)

CHECK MODE SWITCHES
 FOR GRP/PAIR AUX SENDS
 SWK MIX A-D TO AUX 1-4
 PRESS (MIX) (L-REV) (R-REV)
 FOR MAIN/LSR ON AUX
 WITH NOESIS
 AUX 1-4 JACK
 SWK MIX A-D TO AUX 1-4
 PRESS (MIX) (L-REV) (R-REV)

2TRK
 RETURN
 REPLAY TO L-R
 STEREO PFL

STAGE MONITORS 1-8
 LEVEL: -15, -10, -5, 0, +5, +10, +15
 MUTE, AFL, PFL, EDIT REW, EDIT REV

MONITORS 1-10
 LEVEL: -15, -10, -5, 0, +5, +10, +15
 MUTE, AFL, PFL, EDIT REW, EDIT REV

MIXERS 1-10
 MUTE, SAFE/PREVIEW, AFL, PFL, PRE, POST, TRIM, GRP, PAIR, AUX, MON, LISTEN VESG

GROUPS 1-10
 MUTE, SAFE/PREVIEW, AFL, PFL, PRE, POST, TRIM, GRP, PAIR, AUX, MON, LISTEN VESG

MONITOR LEVELS
 METER 1-10, MAIN, SML, -16, -12, -8, -4, 0, +4, +8, +12, +16

MONITOR MIX
 STEREO, MONO, L-R MIX, LOCAL LEV, PHONES LEV

FUNCTIONS
 STORE, PREVIEW, MUTE, RECALL, PATCH, ALL CONSOLE MUTES, L-R MIX TRIM, STEREO = MONO, PHONES LEV, EDIT GROUP, PREVIEW, MUTE, SINGLE, MULTI, GROUP

CHANNELS 24, 1, 2, 3, 4, 5, 6, 7, 8, L, R, MONO, 25